

VARIMETER Reverse Power Monitoring BH 9140, RP 9140

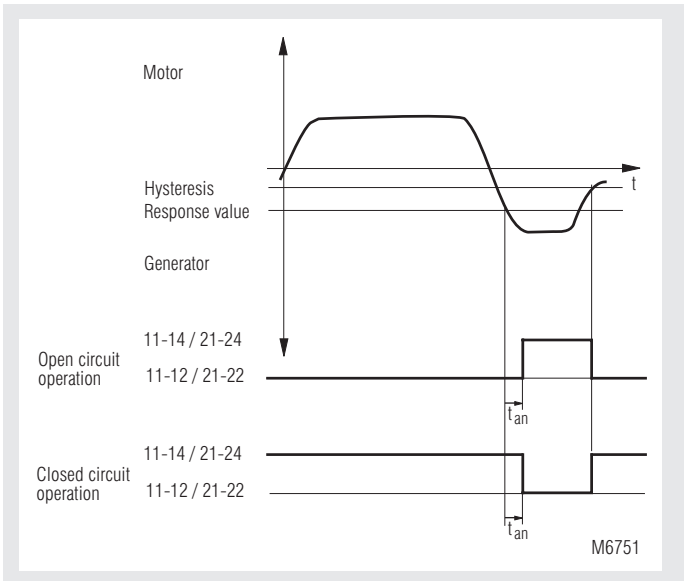

- According to IEC/EN 60 255, DIN VDE 0435-303
- Effective power measuring
- For single and 3-phases
- Adjustable response value 2 ... 20 % reverse power
- Hysteresis 12.5 %
- Rated current BH 9140: 5 A or 40 A
- Rated current RP 9140: 5 A
- Adjustable on delay
- Open circuit operation
- LED indication for voltage supply and contact position
- 2 changeover contacts
- As option closed circuit operation
- Width:
 - BH 9140: 45 mm
 - RP 9140: 70 mm

Function Diagram



Approvals and Marking



Application

The reverse power relays BH 9140 and RP 9140 monitor the direction of the energy transport in an electrical system. This could be necessary at connection points between public supply and industrial mains e. g. when operating emergency power supplies, to avoid taht generators run as motors.

Function

The response value can be adjusted on P_R from 2 ... 20 %. The reverse power is calculated for 3p4w and 3p3w units according to the formula:

$$U_{star} \times I_u \times \cos \varphi \times \text{response value (\%)}$$

At a setting of 20 % and $\cos \varphi = 1$ this is for BH 9140 max.:
 $230 \text{ V} \times 5 \text{ A} \times 0.2 = 230 \text{ W}$
 $230 \text{ V} \times 40 \text{ A} \times 0.2 = 1840 \text{ W}$

and for RP 9140 max. :
 $230 \text{ V} \times 5 \text{ A} \times 0.2 = 230 \text{ W}$

Indication

LED green: on, when auxiliary supply connected
 LED green/red: on, when corresponding output relay is active

Notes

If the current is higher than the nominal current of the device an external current transformer can be used with min. 2.5 VA. The direction of the current has to be observed.

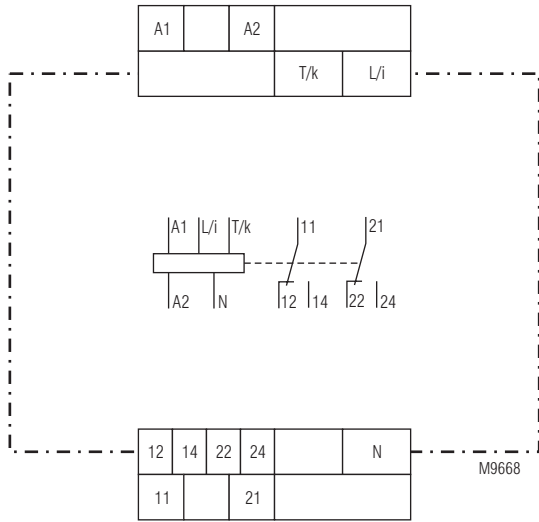

BH 9140: Version for single- and 3-phase connection with N

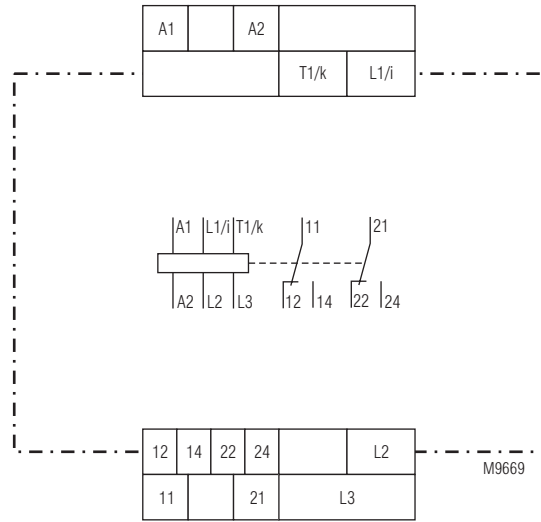

BH 9140: Version for 3-phase connection without N

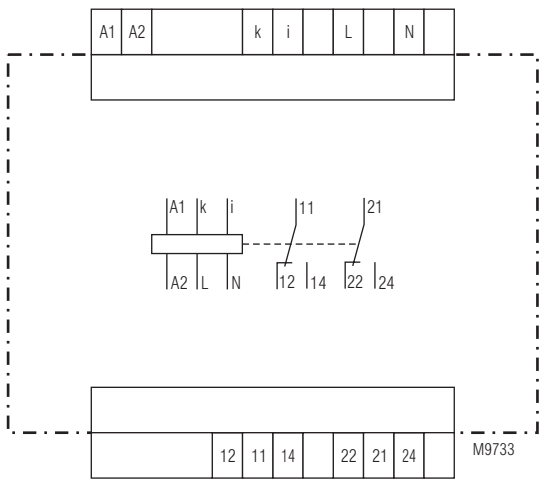

RP 9140: Version for single- and 3-phase connection with N

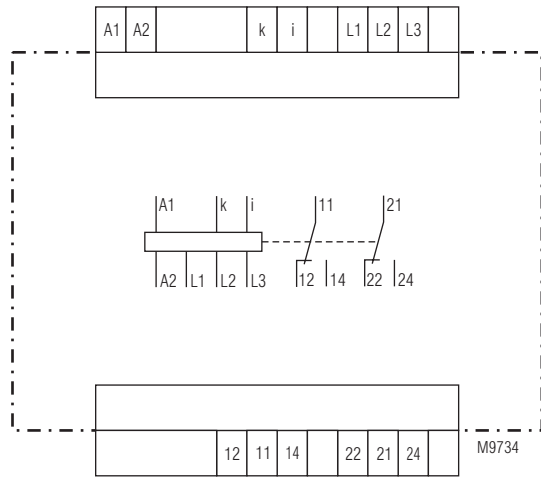

RP 9140: Version for 3-phase connection without N

Technical Data

Measuring Circuit

Voltage

Nominal voltage U_N	
L1-N:	AC 110, 230 V
L1-L2-L3:	3 AC 110, 230, 400, 440 V
max. overload:	1.1 U_N

Current

Nominal current:	5 A / (40 A only for BH 9140)
max. overload:	15 A

Power

Response value:	2 ... 20 % reverse power
Hysteresis:	12.5 % of set response value
Frequency range:	45 ... 65 Hz
On delay t_{an} :	adjustable 0.2 ... 10 s

Auxiliary Circuit

Auxiliary voltage A1, A2:	AC 110, 230, 400, 440 V, DC 24 V*)
	*) only for BH 9140

Voltage range:	0.8 ... 1.1 U_H
Frequency range:	45 ... 65 Hz
Nominal consumption:	< 4 VA

Output

Contacts:	2 changeover contacts	
Thermal current I_{th}:	2 x 5 A	
Switching capacity according to AC 15		
NO contact:	3 A / AC 230 V	IEC/EN 60 947-5-1
NC contact:	1 A / AC 230 V	IEC/EN 60 947-5-1
according to DC 13:	1 A / DC 24 V	IEC/EN 60 947-5-1
Electrical life acc. to AC 15 at 3 A, AC 230 V:	2 x 10 ⁵ switching cycles	
Permissible switching frequency:	1800 switching cycle/H	
Short circuit strength max. fuse rating:	4 A gL	IEC/EN 60 947-5-1
Mechanical life:	30 x 10 ⁶ switching cycles	

General Data

Nominal operating mode:	continuous operation	
Permissible ambient-/storage temperature:	- 20 ... + 60°C	
Clearance and creepage distance rated impuls voltage / pollution degree:	4 kV / 2	IEC 60 664-1
EMC		
Electrostatic discharge (ESD):	8 kV (air)	IEC/EN 61 000-4-2
Fast transients:	2 kV	IEC/EN 61 000-4-4
Surge between wires for power supply:	1 kV	IEC/EN 61 000-4-5
between wire and ground:	2 kV	IEC/EN 61 000-4-5
interference suppression:	Limit value class B	EN 55 011
Degree of protection:		
Housing:	IP 40	IEC/EN 60 529
Terminals:	IP 20	IEC/EN 60 529
Housing:	Thermoplastic with V0 behaviour according to UL subject 94	
Vibration resistance:	Amplitude 0.35 mm Frequency 10 ... 55 Hz IEC/EN 60 068-2-6 20 / 060 / 04 IEC/EN 60 068-1 EN 50 005	
Climate resistance:		
Terminal designation:		
Wire connection BH 9140 load terminals:	1 x 10 mm ² solid or 1 x 6 mm ² stranded wire with sleeve	
control terminal:	1 x 4 mm ² solid or 2 x 1.5 mm ² stranded wire with sleeve or 1 x 2.5 mm ² stranded wire with sleeve DIN 46 228-1/-2/-3/-4	
Wire fixing BH 9140:	Box terminals with self-lifting wire protection and Plus-minus terminal screws M3.5	

Technical Data

Wire connection RP 9140:

fixed screw terminal (S):	0.2 ... 4 mm ² solid or 0.2 ... 1.5 mm ² stranded wire with sleeve
---------------------------	---

Wire fixing RP 9140:

Flat screws M 2,5 box terminals with wire protection DIN rail IEC/EN 60 715	
---	--

Mounting:

Weight:	
BH 9140:	430 g
RP 9140:	250 g

Dimensions

Width x height x depth:

BH 9140:	45 x 84 x 121 mm
RP 9140:	70 x 90 x 71 mm

Standard Types

BH 9140.12/001	3 AC 400 V	5 A	AC 230 V	10 s
Article number:	0060919			

- open circuit operation
- 3-phase connection without neutral
- Response value: 2 ... 20 %
- Nominal voltage U_N : 3 AC 400 V
- Nominal current: 5 A
- Auxiliary voltage U_H : AC 230 V
- On delay: 0.2 ... 10 s
- Width: 45 mm

RP 9140.12/201	3 AC 400 V	5 A	AC 230 V	10 s
Article number:	0061258			

- Open circuit operation
- 3-phase connection without neutral
- Response value: 2 ... 20 %
- Nominal voltage U_N : 3 AC 400 V
- Nominal current: 5 A
- Auxiliary voltage U_H : AC 230 V
- On delay: 0.2 ... 10 s
- Width: 70 mm

Variants

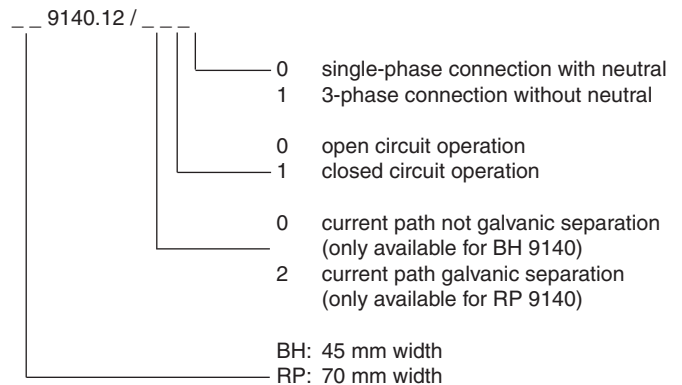

Ordering example for variants

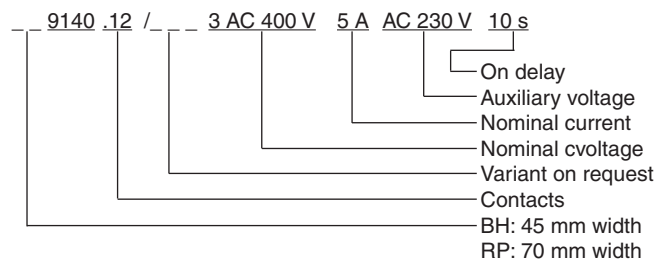

Setting Facilities

Response value	
Reverse power:	2 ... 20 %
On delay:	0.2 ... 10 s

Connection Examples BH 9140

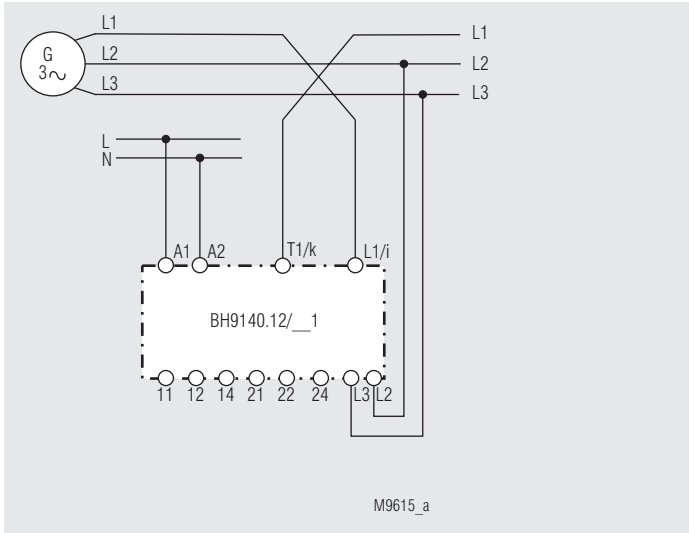

For 3-phase connection without N

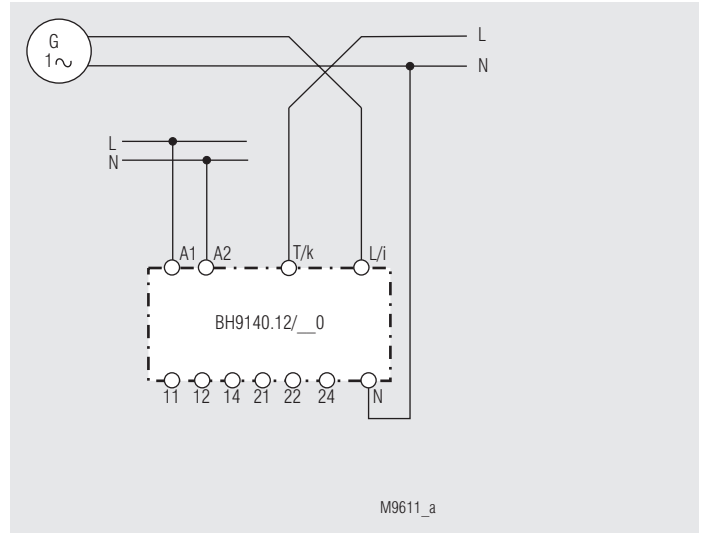

For single or 3-phase connection with N

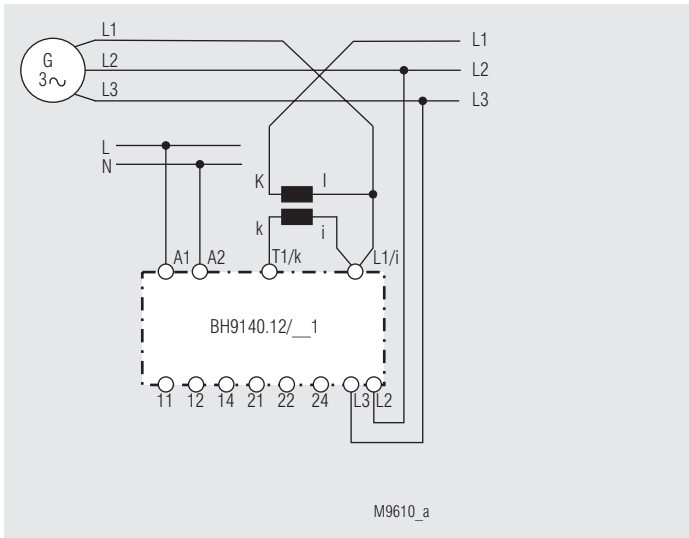

For 3-phase connections with current transformer (external).

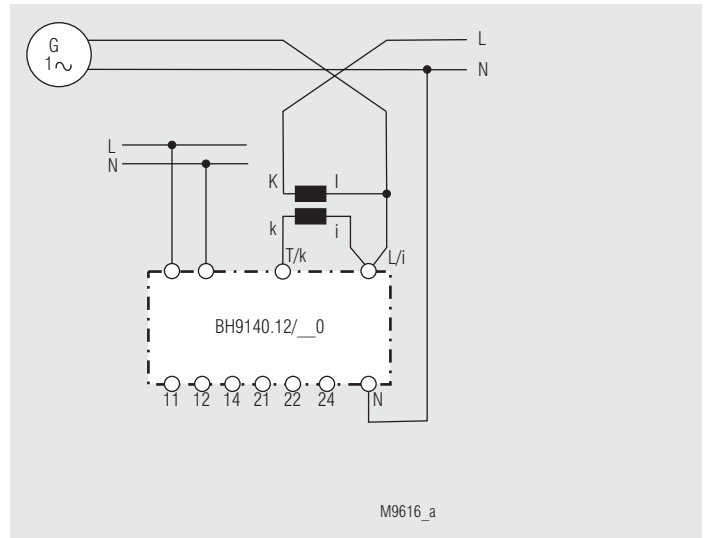

For single or 3-phase connections with current transformer (external)

Connection Examples RP 9140

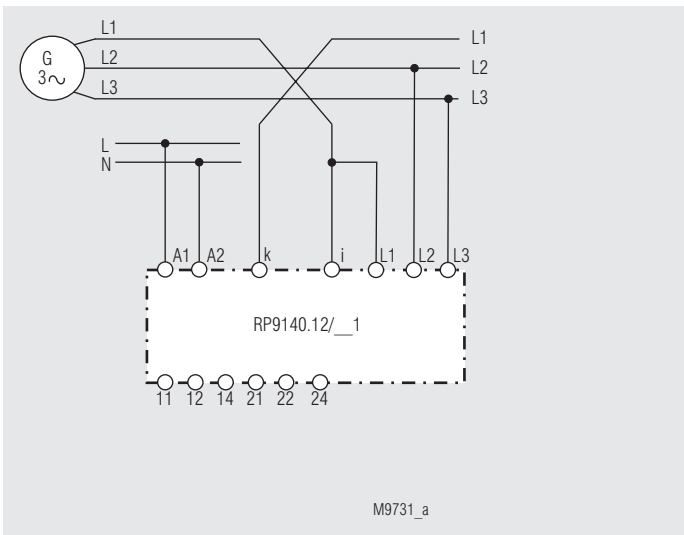

For 3-phase connection without N

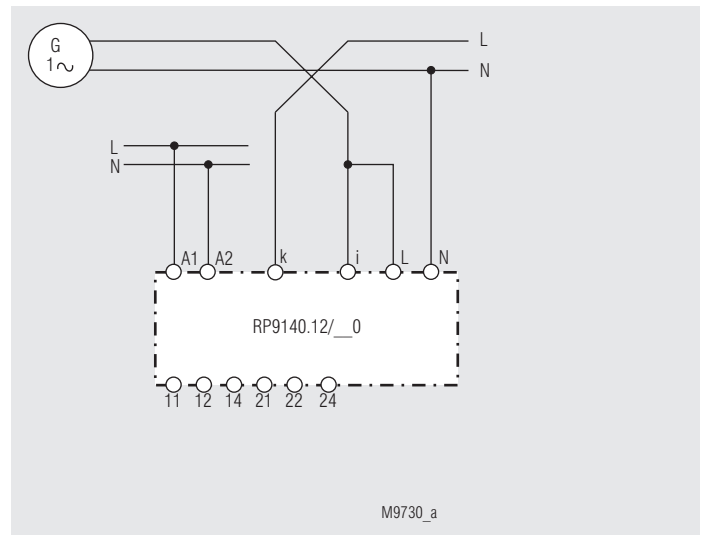

For single or 3-phase connection without N

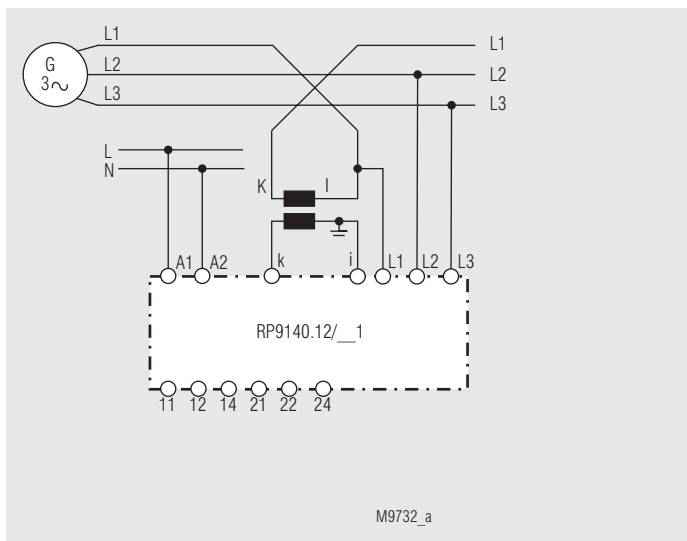

For 3-phase connections with current transformer (external).

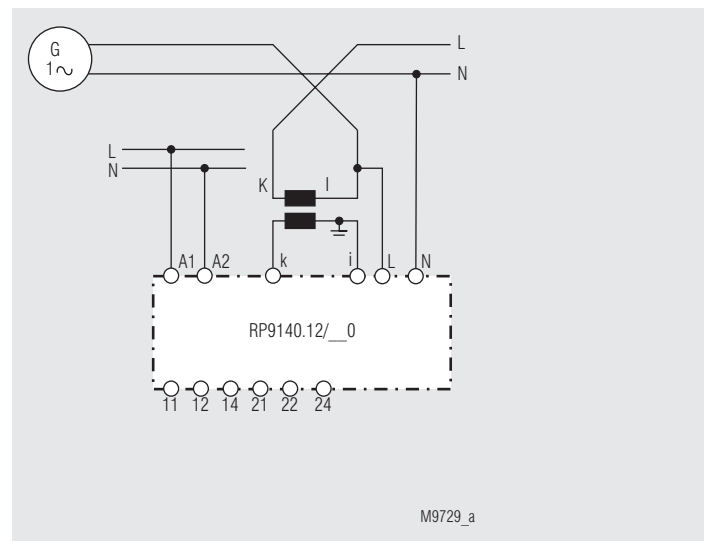

For single or 3-phase connections with current transformer (external)

