

POWERSWITCH
Reversing Contactor
BH 9253

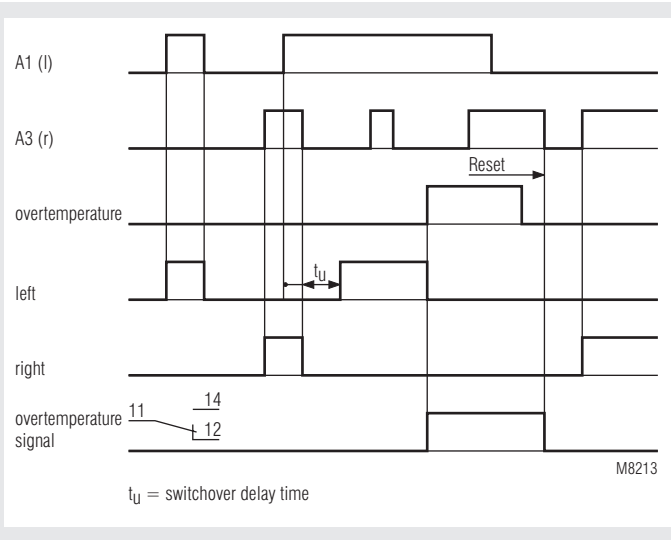

- According to IEC/EN 60 947-1, IEC/EN 60 947-4-2
- Switching at zero-crossing
- To reverse 3 phase asynchronous motors up to 5.5 kW / 400 V (7.5 HP / 460 V)
- Electrical interlocking of both directions
- Temperature monitoring to protect the power semiconductors
- Measured nominal current up to 20 A
- LEDs for status indication
- Galvanic separation between control circuit and power circuit
- 45 mm; 67.5 mm; 112.5 mm width

Function Diagram



Approvals and Marking



Function

The reversing contactor BH 9253 is used to reverse the direction of 3-phase asynchronous motors by switching 2 phases. An electrical interlocking disables the control of both directions at the same time. The reversing contactor has a short on and off delay time. When reversing the phases a switchover delay is guaranteed.

Temperature sensing

To protect the power semiconductors the unit incorporates temperature monitoring. When overtemperature is detected the power semiconductors switch off and an output relay as well as a red LED is activated. This state is stored. When the temperature is back to normal the semiconductors can be activated again by switching off and on the control voltage.

Circuit Diagram

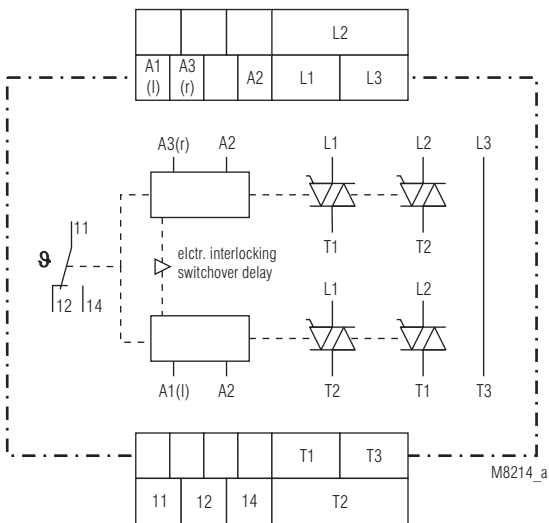

Indication

- yellow LED "l": on, when left direction active
- yellow LED "r": on, when right direction active
- red LED: on, when overtemperature

Technical Data

Input

Nominal voltage

A1,A2 / A3,A2: AC/DC 24 V;
AC 110 ... 127 V, AC 220 ... 240 V, AC 288 V
AC 400 V (no UL-devices)
control voltage A1, A3 has to be connected to the same potential (see appl. example)

Voltage range:

AC: 0.8 ... 1.1 U_N
DC: 0.8 ... 1.25 U_N

Nominal consumption

at AC 230 V: 4 VA, 0.8 W
at DC 24 V: 0.3 W

Nominal frequency:

50 / 60 Hz

Switch on delay:

max. 30 ms

Switch off delay:

typically 25 ms

Switch-over delay t_U :

100 ms (other values on request)

Permissible residual voltage:

30 % U_N

Load Output

	unit without heat sink	with heat sink width 67.5 mm	with heat sink width 112.5 mm
Rated continuous current I_e ¹⁾ [A]	4	12	20
Current reduction above 40 °C [A/°C]	0.1	0.2	0.2
max. motor power at 400 V [kW]	1.1	4	5.5
Nominal motor current I_N [A]	2.6	8.5	11.5
max. locked rotor motor current [A]	15.6	51	69
Example for max. operat. freq. at 100 % duty cycle, 80 % motor load, starting time t_A 2s, starting current $I_A = 6 \times I_N$ [1/h]	250	210	320
Operation mode	AC53a acc. to IEC/EN 60947-4-2		

¹⁾ The rated continuous current I_e is the max. permissible current of the unit in continuous operation.

Note: The max. permissible operating frequency of the motor can be less. See motor data!

Load voltage range: AC 24 ... 480 V

Peak inverse voltage: 1 200 Vp

Frequency range: 50 / 60 Hz

Surge current 10 ms: 300 A

Semiconductor fuse: 450 A²s

Varistor voltage: AC 510 V

Cycle diagram to calculate the operating frequency

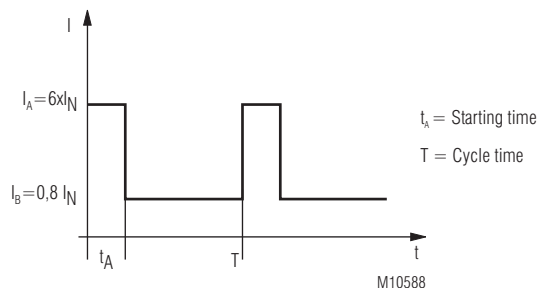

Formula for selection of unit and motor

$$I_e \geq \frac{1}{T} [I_A t_A + I_B (T - t_A)] \quad \text{Device selection}$$

$$I_N^2 \geq \frac{1}{T} [I_A^2 t_A + I_B^2 (T - t_A)] \quad \text{Motor selection}$$

Technical Data

Monitoring Output

Contacts

BH 9253.11: 1 changeover contact
5 A

Thermal current I_{th} :

Switching capacity

at AC 15

NO:

3 A / AC 230 V IEC/EN 60 947-5-1

NC:

1 A / AC 230 V IEC/EN 60 947-5-1

Short circuit strength

max. fuse rating:

4 A gL IEC/EN 60 947-5-1

General Data

Operating mode:

Continuous operation

Temperature range:

- 20 ... + 60 °C

Current reduction over 40 °C: see table

Clearance and creepage distances

rated impuls voltage /

pollution degree:

4 kV / 2 IEC 60 664-1

EMC

Surge voltages: 5 kV / 0.5 J

HF-interference: 2.5 kV

Electrostatic discharge: 8 kV (air)

IEC/EN 61 000-4-2

HF irradiation: 10 V / m

IEC/EN 61 000-4-3

Fast transients: 4 kV

IEC/EN 61 000-4-4

Surge voltages between

wires for power supply:

1 kV IEC/EN 61 000-4-5

HF wire guided:

10 V IEC/EN 61 000-4-6

Interference suppression:

Limit value class B EN 55 011

Degree of protection

Housing:

IP 40 IEC/EN 60 529

Terminals:

IP 20 IEC/EN 60 529

Housing:

Thermoplastic with V0 behaviour

according to UL subject 94

Vibration resistance:

Amplitude 0.35 mm IEC/EN 60 068-2-6

frequency 10 ... 55 Hz

Climate resistance:

20 / 040 / 04 IEC/EN 60 068-1

Terminal designation:

Wire connection

Load terminals:

1 x 10 mm² solid or

1 x 6 mm² stranded ferruled

Control terminals:

2 x 2.5 mm² solid or

2 x 1.5 mm² stranded ferruled

DIN 46 228-1/-2/-3/-4

terminal screws M3.5; box terminals

with self-lifting wire protection

Wire fixing:

DIN rail IEC/EN 60 715

Mounting:

Weight:

BH 9253 with 4 A: 420 g

BH 9253 with 12 A: 640 g

BH 9253 with 20 A: 1 040 g

Dimensions

Width x height x depth:

BH 9253 with 4 A: 45 x 84 x 121 mm

BH 9253 with 12 A: 67.5 x 84 x 121 mm

BH 9253 with 20 A: 112.5 x 84 x 121 mm

UL-Data

	unit without heat sink	with heat sink width 67.5 mm	with heat sink width 112.5 mm
Switching capacity			
Relay			
NO-contact [Vac]	230; 3A; GP		
NC-contact [Vac]	230; 1A; GP		
Short circuit current rating [Arms]	5000		
Ambient conditions	For usage at pollution degree 2; To be used in circuits that allows a max. current of 5000Arms at 460 V. The device has to be fused with a fuse class RK5 25A.		
Rated continuous current I_e ¹⁾ [A]	4	12	20
Ambient temperature [°C]	40 60	40 60	40 60
max. motor power at 460 V [HP]	1,5 0,75	5 3	7,5 5
Nominal motor current FLA (Full load current) [A]	3,0 1,6	7,6 4,8	11 7,6
max. locked rotor motor current LRA [A]	20 12,5	46 32	63,5 46
¹⁾ The rated continuous current I_e is the max. permissible current of the unit in continuous operation.			

Wire connection

Load terminals

L1, L2, L3, T1, T2, T3: 60°C / 75°C copper conductors only
AWG 18 - 8 Sol Torque 0.8 Nm
AWG 18 - 10 Str Torque 0.8 Nm

Control terminals

A1, A2, A3, 11, 12, 14: 60°C / 75°C copper conductors only
AWG 20 - 12 Sol Torque 0.8 Nm
AWG 20 - 14 Str Torque 0.8 Nm



Technical data that is not stated in the UL-Data, can be found
in the technical data section.

Standard Type

BH 9253.11/61 AC 220 ... 240 V 4 A 100 ms

Article number:

0064657

- Output: 1 changeover contact
- Nominal voltage U_N : AC 220 ... 240 V
- Rated continuous current: 4 A
- Switchover delay: 100 ms
- Width: 45 mm

Ordering Example

BH 9253 .11 /61 AC 220...240 V 4 A 100 ms

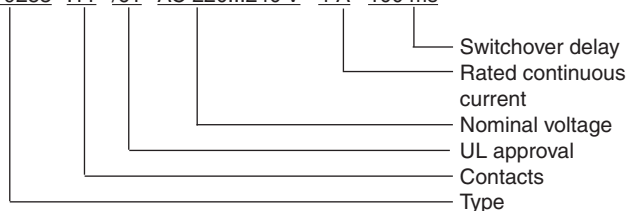

Application Examples

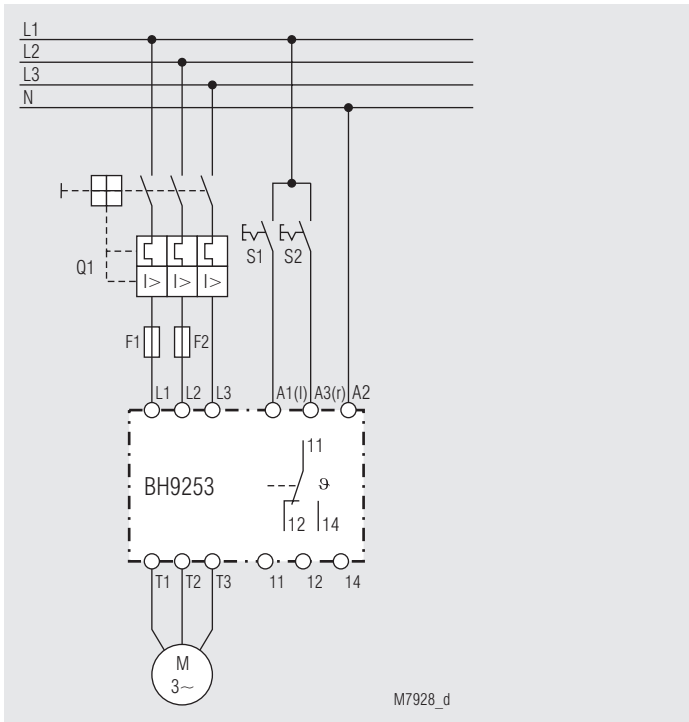

230/400 V AC-Mains
AC 230 V control voltage

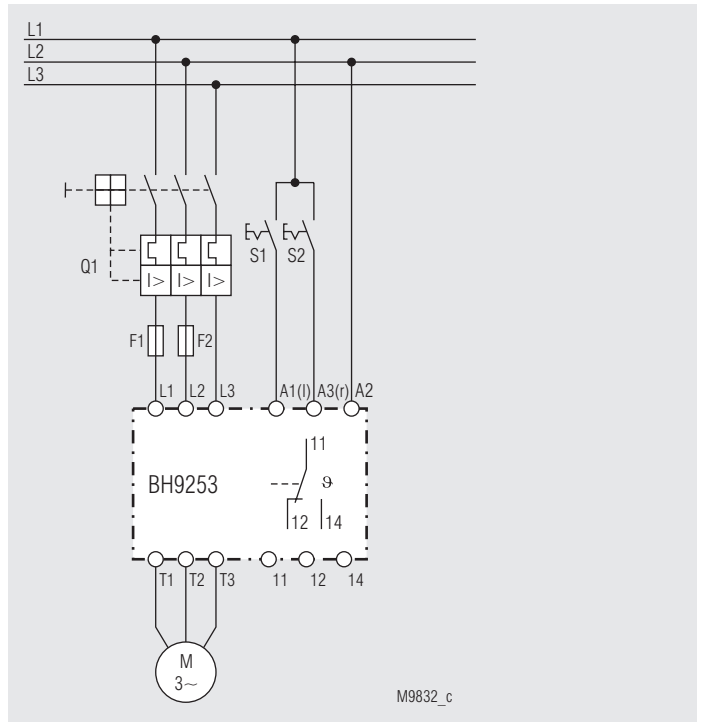

230/400 V AC-Mains
AC 400 V control voltage

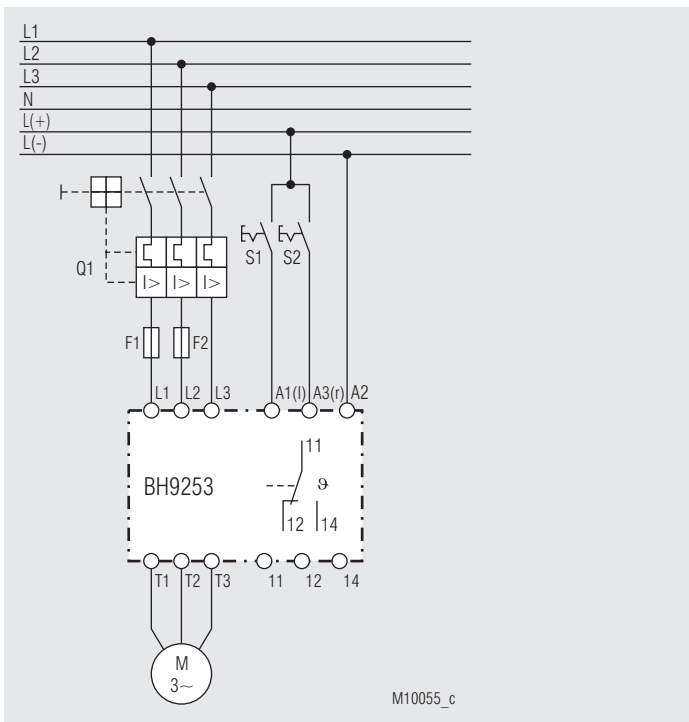

230/400 V AC-Mains
AC/DC 24 V control voltage

ATTENTION!



A1 and A3 has to be connected to the same phase. The common connection is terminal A2.

Connecting a parallel load between A1 and A2 as well as A3 and A2 is not allowed