

VARIMETER Level Sensing Relay MK 9151

Translation
of the original instructions



- According to IEC/EN 60255-1
- 3 probe connections for 2-point and 1-point level control
- Also for use as moisture detector
- High interference resistance of the measuring circuit, which is isolated from the mains
- Max. wire length to the probes: 3000 m
- Large setting range: 2 ... 450 kΩ
this permits differentiation between fluid and foam
- Adjustable response and release time delay: 0.2 ... 20 s
- Programmable for open circuit operation (without bridge) or closed circuit operation (bridge X1-X2 or X1-COM)
- For auxiliary voltages of 24 ... 415 V AC or 24 V DC
- Green LED for operation
- Yellow LED for contact position
- 1 or 2 changeover contacts
- Also available with sealable transparent cover
- Available with safe separation according to IEC/EN 61140, IEC/EN 60947-1
- Width 22.5 mm

Function Diagram

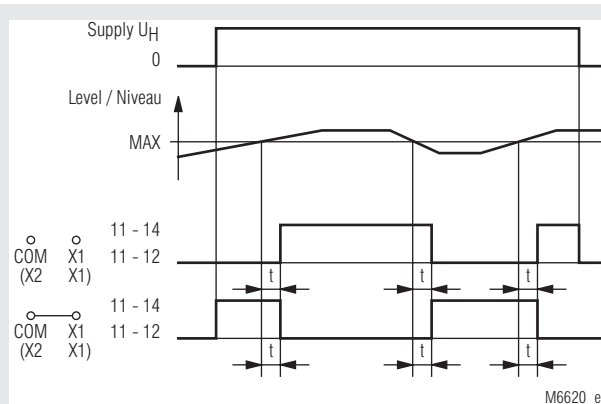

1-point level control

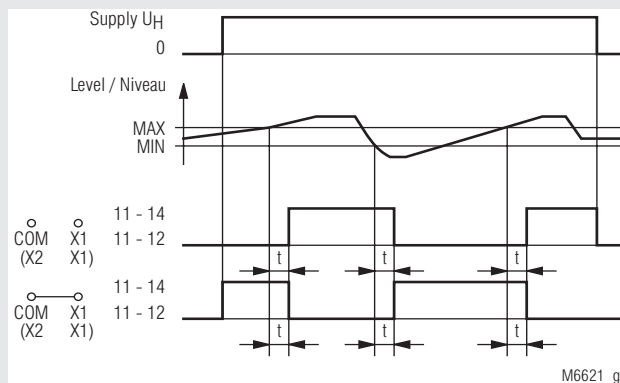

2-point level control

Circuit Diagrams

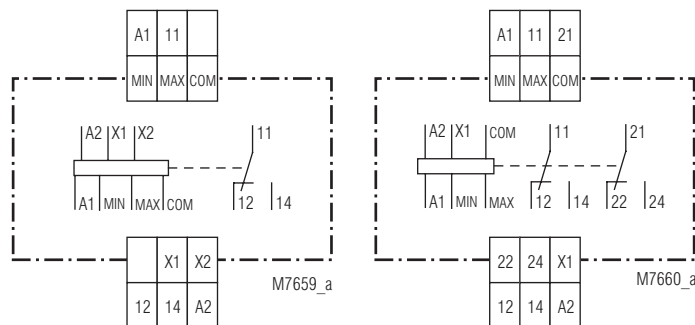

MK 9151.11

MK 9151.12

Approvals and Markings



Applications

- Level monitoring and control for conductive liquids and powders, e.g. maximum and minimum filling levels, overfilling and protection against dry running
- Monitoring and control of the mixing ratio of conductive liquids
- General resistance monitoring tasks, e.g. limit temperature detection with PTC

Indicators

Green LED:	On, when supply connected
Yellow LED:	On, when output relay active

Connection Terminals

Terminal designation	Signal description
A1	+ / L
A2	- / N
COM	Connection reference probe
MIN, MAX	Connection MIN-MAX probe
X1	Control input
X2	Control output
11, 12, 14	Changeover contacts
21, 22, 24	Changeover contacts

Notes

All commercially available probes are suitable.

The reference probe for level measurement is generally located at the lowest point of the container and must always be connected to the "COM" terminal. The container itself can be used as a reference probe if it consists of conductive material.

1-point level control (see Figure) is especially suitable for protection against overflowing and dry running on containers with a free inlet/outlet. In this configuration, all that is required besides the reference probe "COM" is the "MAX", which must be located at the desired limit level. The output relay switches over after the set delay time if the fluid level exceeds or falls below the limit level, which permits fluid to be pumped out or added.

The 2-point control is selected when a liquid should be kept between "MIN" and "MAX" level. This requires the connection of all 3 Probes "MIN", "MAX" and "COM". If the liquid rises above the "MAX" level the output contact changes over after the adjusted time delay and starts a pump to empty the tank or closes a magnet valve. At the same time internally the probe "MIN" is integrated into the measuring circuit. So when the liquid goes under the "MAX" level, the measuring current still flows via the "MIN" probe. This keeps the output relay and the "MIN" probe active until the liquid goes under the "MIN" level. At this point the output relay switches back after the adjusted time delay and the "MIN" probe is disconnected from the measuring system until again the "MAX" level is reached.

The wide setting range allows easily an optimum setting so that the unit can differentiate between foam and liquid. The response value must be set to a value high enough, that the unit reacts when the liquid, but not when the foam reaches the probe (for setting procedure the time delay is set to min. value).

Because of the settable time delay that acts on the output relay as well as on the internal probe control, it is possible to suppress early switching caused by waves on the liquid. Also time depending level control can be realised. The delay works integrating and is active when the liquid goes over as well as under the probe level.

Technical Data

Input

Setting range of the fluid resistance: 2 ... 450 k Ω ; 0.02 ... 4.5 M Ω
(other ranges on request)
Setting: On logarithmically divided absolute scale
Switching point hysteresis: Approx. 3 % (at max. setting) to 6 % (at min. setting) of the set value

Voltage and temperature influence:

< 2 % of the set value

Max. cable length to the probes:

	Set value	Cable length (at 100 nF/km)
Setting range 2 ... 450 k Ω :	450 k Ω	50 m
	100 k Ω	200 m
	35 k Ω	500 m
	10 k Ω	1500 m
	5 k Ω	3000 m
Setting range 0,02 ... 4,5 M Ω :	4.5 M Ω	5 m
	1.0 M Ω	20 m
	0.5 M Ω	50 m
	0.1 M Ω	150 m
	0.02 M Ω	300 m

Max. sensing voltage:

Approx. AC 10 V (internally generated)

Max. sensing current:

Setting range 2 ... 450 k Ω : Approx. AC 1.5 mA (internally generated)
Setting range 0.02 ... 4.5 M Ω : Approx. AC 0.2 mA (internally generated)

Response and release times:

0.2 ... 20 s
Setting on logarithmically-divided absolute scale

Auxiliary Circuit

Auxiliary voltage U_H : AC 24, 42 ... 48, 110 ... 127, 220 ... 240, 380 ... 415 V
DC 24 V

Voltage range of U_H :

AC: 0.8 ... 1.1 U_N
DC: 0.85 ... 1.25 U_N

Nominal power consumption:

AC: Approx. 2 VA
DC: Approx. 1 W

Frequency range:

45 ... 400 Hz

Output

Contacts

MK 9151.11: 1 changeover contact
MK 9151.12: 2 changeover contacts
Thermal current I_{th} : 5 A

Switching capacity

To AC 15

NO contact: 3 A / AC 230 V IEC/EN 60947-5-1
NC contact: 1 A / AC 230 V IEC/EN 60947-5-1

Electrical life

To AC 15 at 1 A, AC 230 V: 5 x 10⁵ switching cycles
Permissible operating: 6000 switching cycles / h

Short-circuit strength

Max. fuse rating: 4 A gG / gL IEC/EN 60947-5-1
Mechanical life: 30 x 10⁶ switching cycles

Technical Data

General Data

Operating mode: Continuous operation

Temperature range:

Operation: - 20 ... + 60 °C

Storage: - 20 ... + 60 °C

Altitude: ≤ 2000 m

Clearance and creepage distances

Rated impulse voltage /
pollution degree

IEC 60664-1

Input/auxiliary circuit: 6 kV / 2 (1 kV for DC 24 V-devices)

Input/output circuit: 6 kV / 2 (4 kV for MK 9151.12)

Auxiliary/output circuit: 4 kV / 2

MK 9151.12:

Contact/contact: 4 kV / 2

MK 9151. __ /106:

Input/auxiliary circuit: 6 kV / 2 (1 kV at DC 24 V devices)

Input/output circuit: 6 kV / 2

Auxiliary/output circuit: 6 kV / 2

EMC

Electrostatic discharge: 8 kV (air) IEC/EN 61000-4-2

HF irradiation:

80 MHz ... 1 GHz 20 V/m IEC/EN 61000-4-3

1 GHz ... 2 GHz 20 V/m IEC/EN 61000-4-3

2 GHz ... 2.7 GHz 1 V/m IEC/EN 61000-4-3

Fast transients: 2 kV IEC/EN 61000-4-4

Surge voltages

Between

wires for power supply: 2 kV IEC/EN 61000-4-5

Between wire and ground: 4 kV IEC/EN 61000-4-5

HF wire guided: 10 V IEC/EN 61000-4-6

Interference suppression

Auxiliary voltage AC: Limit value class B EN 55011

Auxiliary voltage DC: Limit value class A*) EN 55011

*) The device is designed for the usage under industrial conditions (Class A, EN 55011). When connected to a low voltage public system (Class B, EN 55011) radio interference can be generated. To avoid this, appropriate measures have to be taken.

Degree of protection

Housing: IP 40 IEC/EN 60529

Terminals: IP 20 IEC/EN 60529

Housing:

Thermoplastic with V0 behavior according to UL subject 94

Vibration resistance:

Amplitude 0.35 mm, frequency 10 ... 55 Hz, IEC/EN 60068-2-6

20 / 060 / 04 IEC/EN 60068-1

Climate resistance:

Terminal designation:

Wire connection:

2 x 1.5 mm² solid or 2 x 1.0 mm² stranded wire with sleeve DIN 46228-1/-2/-3/-4

Wire fixing:

Flat terminals with self-lifting clamping piece IEC/EN 60999-1

Fixing torque:

0,4 Nm

Mounting:

DIN rail IEC/EN 60715

Weight:

155 g

Dimensions

Width x height x depth: 22.5 x 82 x 99 mm

Standard Type

MK 9151.11 2 ... 450 kΩ AC 220 ... 240 V

Article number: 0044505

- Output: 1 changeover contact
- Measuring range: 2 ... 450 kΩ
- Auxiliary voltage U_H: AC 220 ... 240 V
- Width: 22.5 mm

Variants

MK 9151. __ /001: Time delay on Min level

MK 9151. __ /002: Time delay on Max level

MK 9151. __ /106: With save separation according to IEC/EN 61140, IEC/EN 60947-1

MK 9151. __ /800: With integrated suppressor capacitor between probes MAX and COM to be used in systems with inverters and reduced setting range of response value 2 ... 15 kOhms

Ordering example for variants

MK 9151 .12 / _ _ _ 2 ... 450 kΩ AC 220 ... 240 V

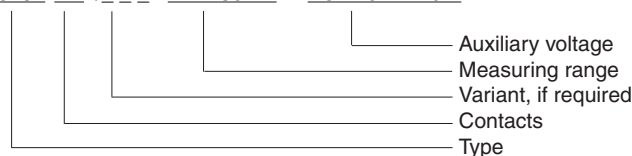

Accessories

OA 5640: Standard probe
Article number: 0016045

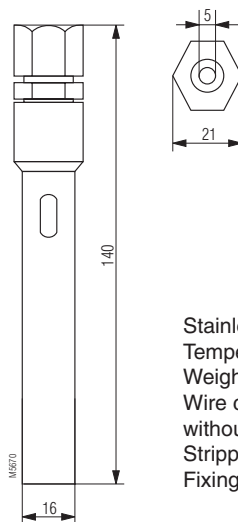

Stainless steel immersion electrode,
Temperature range: 0 ... + 60 °C,
Weight: Approx. 0.1 kg
Wire connection: 1.5 mm² stranded wire with sleeve without plastic collar
Stripping length: 10 mm
Fixing torque: 0.6 Nm

Application Examples

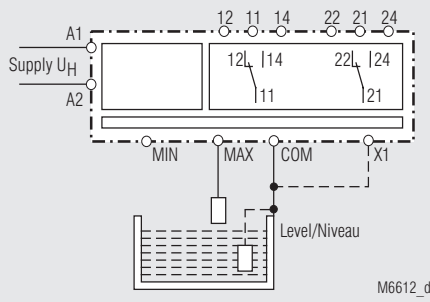

1-point level control

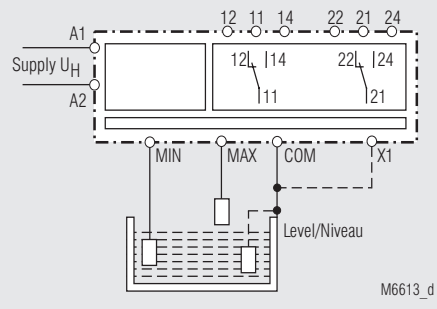

2-point level control