

- According to DIN EN 61810-1, DIN EN 61810-3 (Type A)
- With forcibly guided contacts
- **Double and reinforced insulation between contact sets acc. to EN 50178**
- High dielectric strength
- High mechanical service life
- High switching reliability
- Compact size
- High thermal continuous current
- High voltage range
- Wash proof model as option

Applications

- Switchgear for safety technology
- Press controls

Approvals and Markings



Technical Data

Relais type	OA 5670
1.0 Relais coil	
1.1 Nominal voltage	DC 6; 12; 20; 24; 48; 60; 110 V (others on request)
1.2 Nominal consumption	1.0 W
1.3 Holding power (at 0.5 x UN)	0.25 W
2.0 Contacts	
2.1 Contact arrangement (Type A)	2 NO and 2 NC; 3 NO and 1 NC
2.2 Contact material	AgSnO ₂ + 0.2 µm Au; AgNi + 0.2 µm Au, AgNi + 5 µm Au
2.3 Rated insulation voltage	AC 250 V
Switching voltage min./max	AC/DC 10 V / DC 250 V, AC 400 V (AC/DC 2 V / 60 V) ¹⁾
2.4 Limiting continuous current I _{th}	3 x 6 A (see operating voltage limit curve)
Switching current min./max.	10 mA ²⁾ / 6 A (2 mA / 0.3 A) ¹⁾
2.5 Switching power min./max.	0.1 VA / 1500 VA (10 mVA / 12 VA) ¹⁾
Switching power min./max.	0.1 W ²⁾ / 200 W (10 mW / 12 W) ¹⁾ (s. limit curve for arc-free operation)
2.6 Switching capacity to IEC/EN 60947-5-1	
AC 15 ³⁾	NC: AC 250 V / 1 A NO: AC 250 V / 2 A
AC 15 ⁴⁾	NC: AC 250 V / 1 A NO: AC 250 V / 3 A
DC 13 ³⁾	NC: DC 24 V / 1 A NO: DC 24 V / 1 A
DC 13 ³⁾ at 0.1 Hz	NC: DC 24 V / 3 A NO: DC 24 V / 4 A
to UL 508	B300 / R300
2.7 Electrical life	At 1 s On, 1 s Off (see contacts service life)
at AC 230 V, 6 A, cosφ = 1	> 2,6 x 10 ⁵ switching cycles AgNi
at DC 24 V, 6 A ohmsch	> 4 x 10 ⁶ switching cycles AgNi
2.8 Switching frequency max.	10 switching cycles/s
2.9 Response time / Release time	Typically 11 ms / Typically 6 ms
2.10 Contact force NO / NC	≥ 10 cN
2.14 Contact gap	> 0.5 mm ⁵⁾
3.0 Other	
3.1 Mechanical life	≥ 50 x 10 ⁶ switching cycles
3.2 Temperature range	- 40 ... + 75 °C
3.3 Degree of protection, housing	Solder line proof RT II as option wash proof RT III
3.4 Test procedure	A (group mounting)
3.5 Vibration resistance	10 ... < 60 Hz; 0.35 mm Amplitude IEC/EN 60068-2-6 60 ... 200 Hz, ≤ 5g (all contacts) IEC/EN 60068-2-6
3.6 Climate resistance	40 / 075 / 04; A / B / D IEC/EN 60068-1
3.7 Short circuit strength 1 kA / AC 250 V	AgNi or AgSnO ₂ 6 A gG / gL IEC/EN 60947-5-1

¹⁾ Values for AgNi-Contacts + 5 µm Au

²⁾ Typical values for AgSnO₂ and AgNi

³⁾ Values for AgNi-Contacts

⁴⁾ Values for AgSnO₂-Contacts

⁵⁾ Over entire service life acc. to DIN EN 61810-3

Technical Data

3.8	Insulation acc. to IEC 60664-1, EN 50178	Double and reinforced insulation
	Rated insulation voltage	AC 250 V
	Pollution degree	3
	Overtoltage category	III
	Test voltage	
	Contact-Coil (1 min)	≥ AC 4 kV eff.
	Left contact-right contact (1 min)	≥ AC 4 kV eff.
	Contact-Coil (1 min)	≥ AC 3 kV eff.
	Contact open (1 min)	≥ AC 1.5 kV eff.
	Transient voltage	
	Contact-Coil (1.2 - 50 μs)	≥ 6 kV
	Clearance and creepage distances	
	Contact-Coil	≥ 8 mm
	Left contact-right contact	≥ 5.5 mm
	Contact-Contact	≥ 4.5 mm
3.9	Weight	Approx. 21 g
4.0 Packing		
4.1	On cardboard	42 pieces
4.2	In case package	210 pieces
5.0 Solder method		
5.1	Solder method /-temperature /-duration	Wave soldering / 260 °C / 5 s

Design versions

U _N (DC V)	Voltage range (DC V)	R _{Coil} Ω ± 10%	OA 5670	
			.52 2NO, 2NC	.48 3NO, 1NC
AgNi10 + 0,2 μm Au-contacts				
6	4.2 ... 8.4	36	3201	3211
12	8.4 ... 16.8	150	3202	3212
20	14.0 ... 28.0	400	3203	3213
24	16.8 ... 33.6	580	3204	3214
48	33.6 ... 67.2	2300	3205	3215
60	42.0 ... 84.0	3600	3206	3216
110	77.0 ... 154.0	12100	3207	3217
AgSnO ₂ + 0,2 μm Au-contacts				
6	4.2 ... 8.4	36	3221	3231
12	8.4 ... 16.8	150	3222	3232
20	14.0 ... 28.0	400	3223	3233
24	16.8 ... 33.6	580	3224	3234
48	33.6 ... 67.2	2300	3225	3235
60	42.0 ... 84.0	3600	3226	3236
110	77.0 ... 154.0	12100	3227	3237
AgNi10 + 5 μm Au-contacts				
6	4.2 ... 8.4	36	3241	3251
12	8.4 ... 16.8	150	3242	3252
20	14.0 ... 28.0	400	3243	3253
24	16.8 ... 33.6	580	3244	3254
48	33.6 ... 67.2	2300	3245	3255
60	42.0 ... 84.0	3600	3246	3256
110	77.0 ... 154.0	12100	3247	3257

Ordering Example

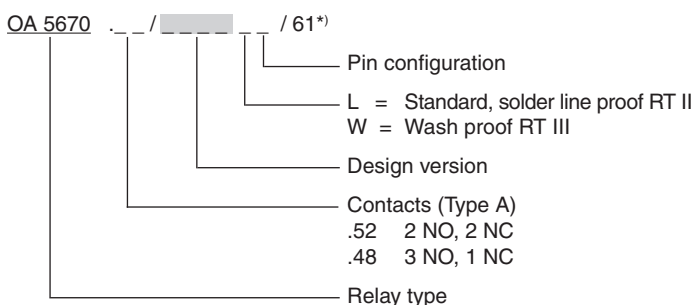

Notes

For the use and processing of our PCB relays, please refer to the **application and processing instructions** at www.dold.com

*) /61 cURus approval

Characteristics

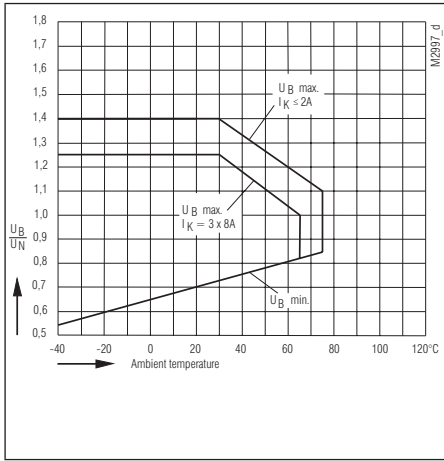

Operating voltage limit curve

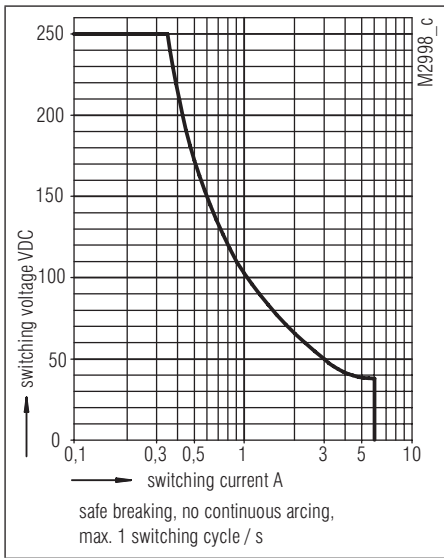

Arc limit curve

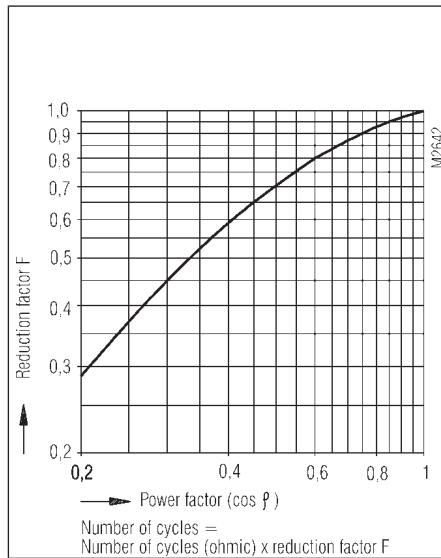

Reduction factor for reactive loads

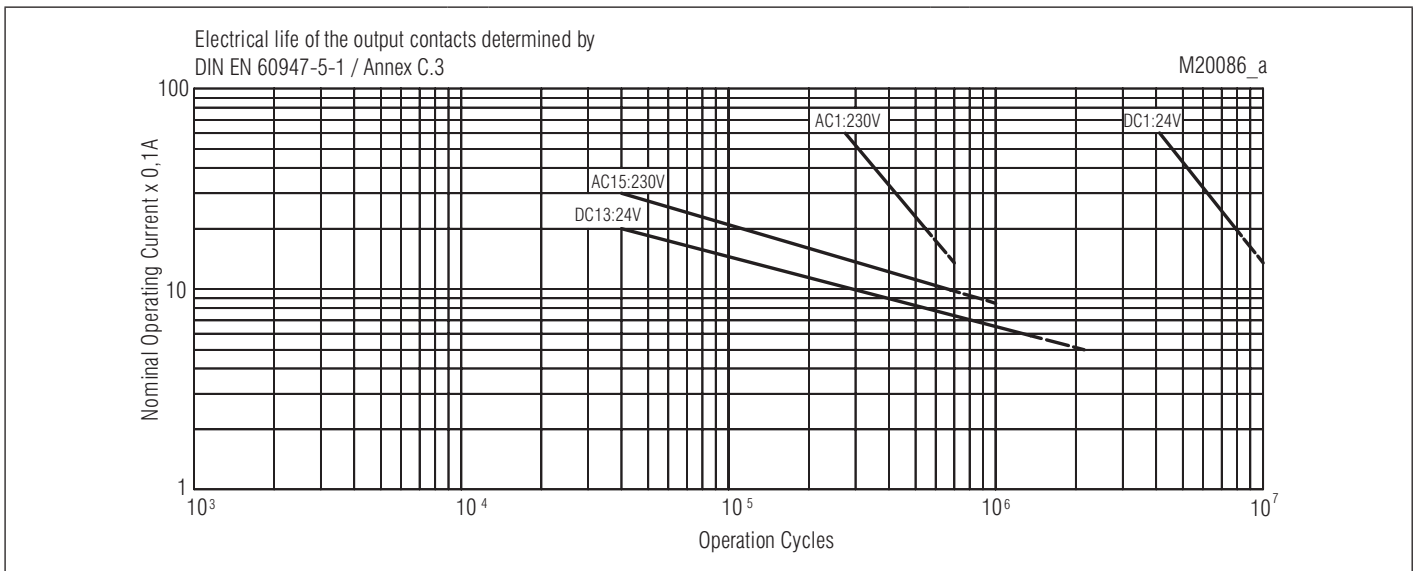

Electrical life for contact material AgNi

Drilling plan (solder side)

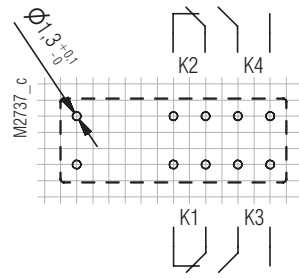
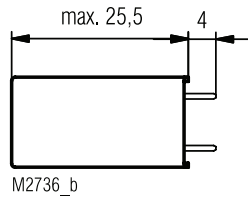
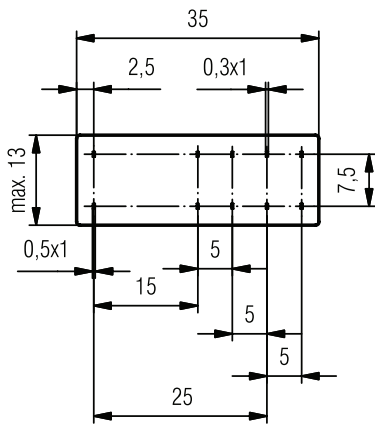

OA5670.52__L1 2NO/2NC

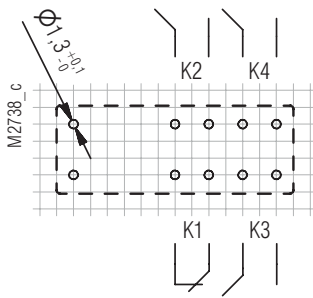

OA5670.48__L1 3NO/1NC

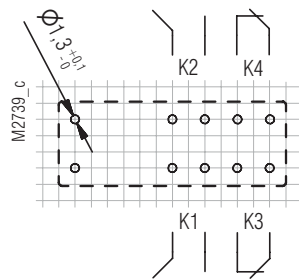

OA5670.52__L2 2NO/2NC

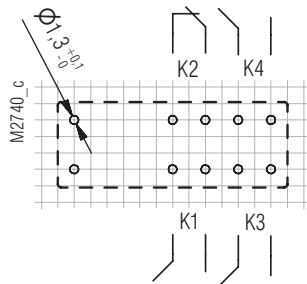

OA5670.48__L2 3NO/1NC

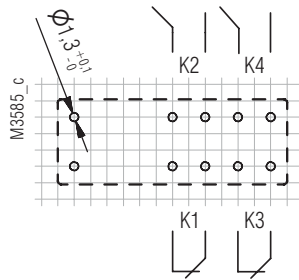

OA5670.52__L3 2NO/2NC

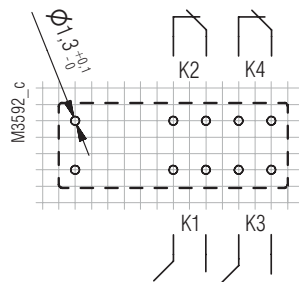

OA5670.52__L4 2NO/2NC

Connection for basic grid dimensions 2.5 mm as well as 2.54 mm according to IEC/EN 60097 and IEC 60326 average

Relay socket ET 1415.034 for OA 5670

Article number: 0064297

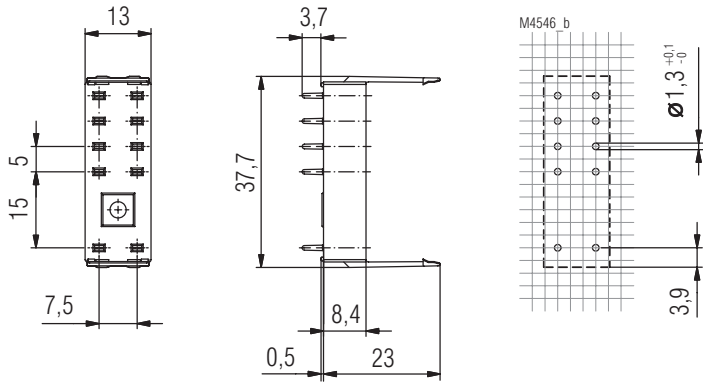

This form consists of a large grid of graph paper. The grid is composed of solid lines forming an outer border and dotted lines forming an inner margin. The grid is intended for technical drawing or calculations.

This section contains a series of horizontal lines on the right side of the page. It is likely intended for a table of contents or an index, where each line would correspond to a page number and a topic.

