

## POWERSWITCH Solid-state Relay / - Contactor With Load Circuit Monitoring PH 9270

Translation  
of the original instructions

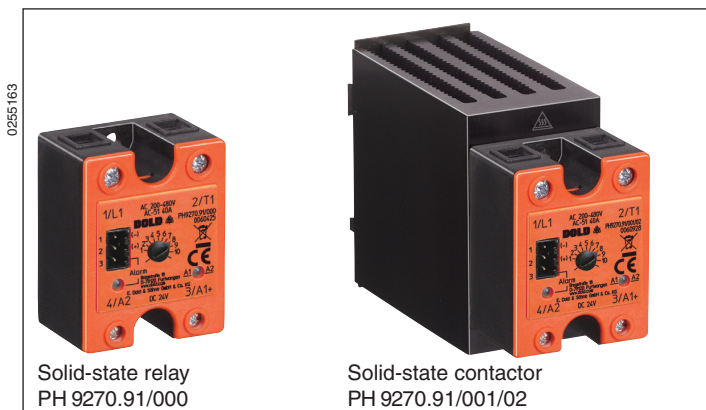

0255163

Solid-state relay  
PH 9270.91/000

Solid-state contactor  
PH 9270.91/001/02

- AC solid-state relay /-contactor
- With integrated load circuit monitoring
- Settable load limit value
- According to IEC/EN 60947-4-3
- Load current 40 A, AC 51
- Switching at zero crossing
- 2 anti-parallel thyristors
- DCB technology (direct bonding method) for excellent heat transmission properties
- Two-colours LED status indicator
- Touch protection IP20
- PLC compatible alarm output (PNP; NPN on request)
- As option closed circuit operation or open circuit operation
- As option with optimized heat sink, for DIN rail mounting
- Width 45 mm

### Circuit Diagram

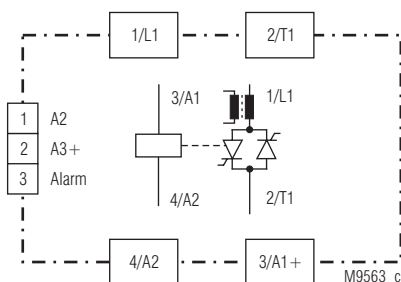

PH 9270.91

### Connection Terminals

Terminal designation	Signal description
A1+, A2	Control input
A3+, A2	Operating voltage, load circuit monitoring
Alarm	Solid-state outputs
L1	Network
T1	Load output

### Indication

The LED „A1/A2“ shows the state of the control input  
 Yellow: Controlled semiconductor relays  
 Off: Not controlled semiconductor relays

The LED „Alarm“ shows the state of the unit  
 Green: No failure  
 Red: Failure (thyristor defective with open or short circuit, open load, current value too high or too low or supply voltage < 100 V AC)  
 Off: No auxiliary voltage (A3+/A2)

### Notes

#### Overtemperature protection

Optionally, the solid-state relay has an overtemperature protection to monitor the temperature of the heat sink. For this purpose, a thermal switch (NC contact) can be inserted into the respective pocket at the bottom of the solid-state relay. As soon as the temperature of the heat sink exceeds for example 100°C, the thermal switch opens. For thermal protection of the solid-state relay, a thermal switch of *UCHIYA* type UP62 – 100 can be installed.

### Approvals and Markings



\*) The installation must only be done by a qualified electrician!

### Applications

For high frequency wear free and noiseless switching of  
 - Heating systems  
 - Motors  
 - Valves\*  
 - Lighting systems

The semiconductor switches at zero crossing. The integrated load monitoring provides fast fault finding e.g. broken load elements (part load failure), broken load circuit, overcurrent, missing load voltage, blown fuse and thyristor faults.

The PH 9270 is suitable for many applications e. g. extrusion machines for plastic and rubber, packaging machines, solder lines, machines in food industry.

\* On overcurrent monitoring a start up delay must be integrated in the control.

### Function

The solid-state relay PH 9270 monitors with applied auxiliary voltage (A3+/A2) the load voltage and the load current. On broken load circuit, deviations of the load current from setting value or defective semiconductor an alarm output is controlled. The failure state is indicated on a 2-color LED (see Function Diagrams).

The PH 9270 with 2 antiparallel connected thyristors switches at zero crossing. When connecting the control voltage the semiconductor is switched on with the next zero crossing of the sinusoidal voltage. After disconnecting the control voltage the semiconductor switches off with the next zero crossing of the load current.

As option the PH 9270 is available with heat sink for DIN rail mounting and immediately "ready to use". In addition the heat dissipation is optimised.

## Function Diagram

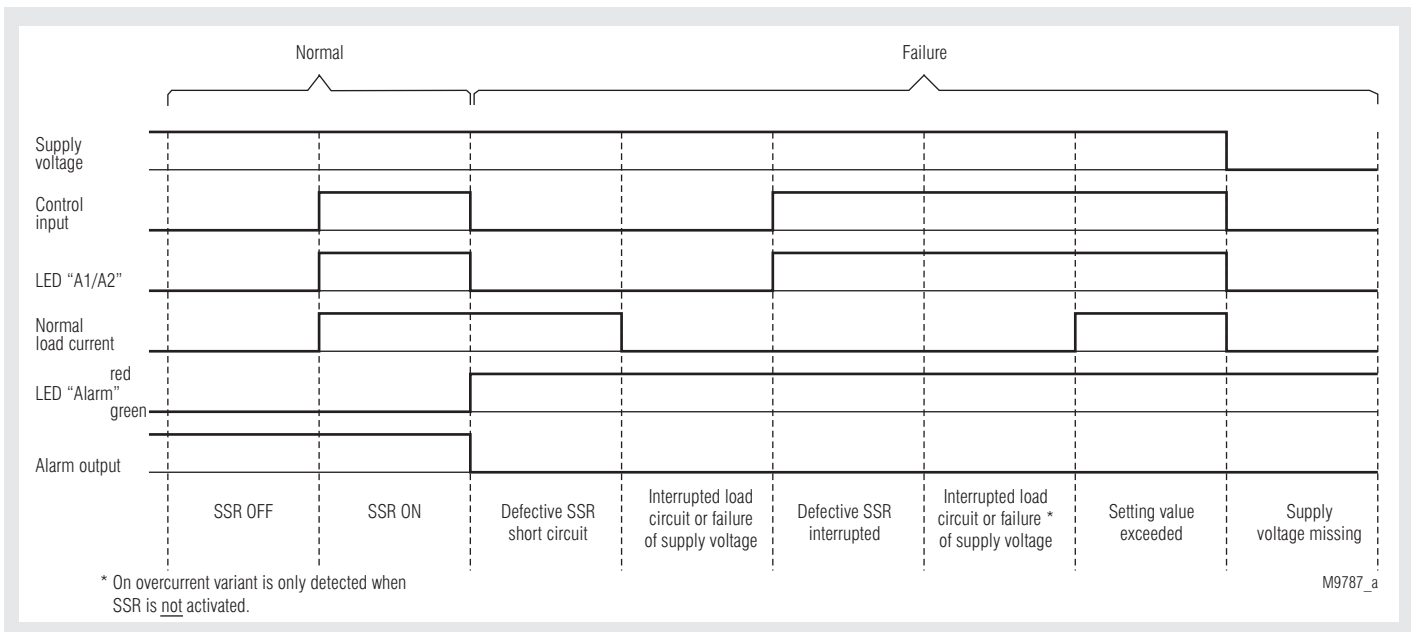

### Normal operation and failure status

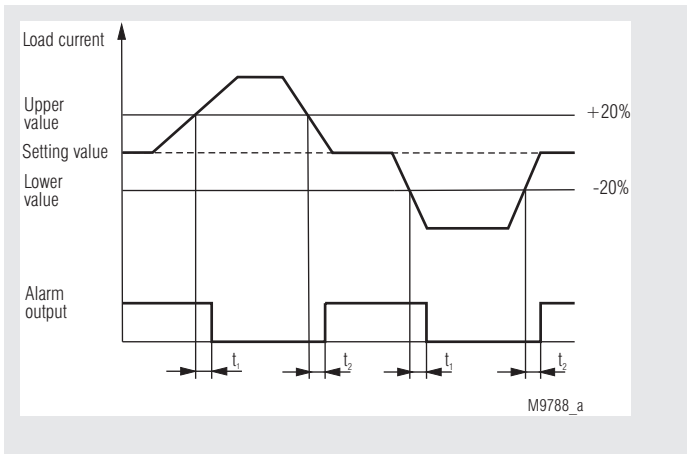

Over- / Undercurrent detection variant /000

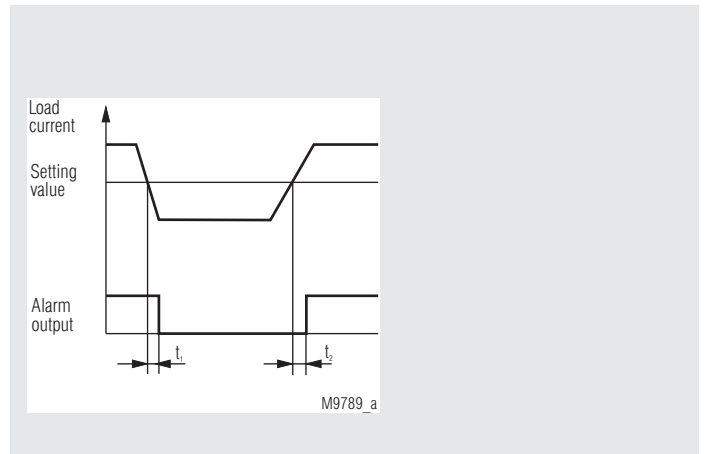

Undercurrent detection variant /001 (inverted alarm output on request)

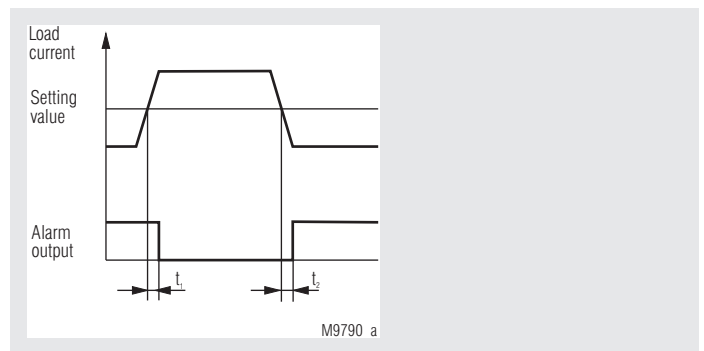

Overcurrent detection variant /002

## Technical Data

### Output

Load voltage AC [V]:	200 ... 480
Frequency range [Hz]:	47 ... 63
Load current [A], (AC 51):	40
Load limit integral $I^2t$ [A <sup>2</sup> s]:	1800; 6600 <sup>*)</sup>
Max. overload current [A] t = 10 ms:	600; 1150 <sup>*)</sup>
Period. underload current [A] t = 1 s:	120; 150 <sup>*)</sup>
Forward-voltage [V]	
at nominal current:	1.4
Off-state voltage [V/μs]:	500
Rate of rise of current [A/μs]:	100
Measuring range:	0,5 ... 40 A
Response value:	Continuously variable
Hysteresis:	2 % of response value

### Temperature Data

Thermal resistance junction - housing [K/W]:	0.5
Thermal resistance housing - ambient [K/W]:	12
Junction temperature [°C]:	≤ 125

\*) Variant /1\_\_

### Alarm Output

Auxiliary supply A3+/A2 [V]:	20 ... 32 (DC)
Max. input current [mA]:	15 bei 24 V DC
<b>PNP transistor outputs</b>	
Max. output current [mA]:	100
Output voltage (open) [V]:	0 (DC)
(closed) [V]:	Auxiliary supply -2 V DC (max.)
Time delay [ms]:	220

### Control Circuit

Control voltage A1+/A2 [V]:	20 ... 32 (DC)
Switch off voltage [V]:	0 ... 5 (DC)
Max. input current [mA]:	10 at 24 V DC
Turn-on delay [ms]:	5 + 1/2 Periode
Turn-off delay [ms]:	20 + 1/2 Periode

### General Data

<b>Operating mode:</b>	Continuous operation	
<b>Temperature range</b>		
Operation:	- 20 ... 40 °C	
Storage:	- 20 ... 80 °C	
<b>Clearance and creepage distances:</b>		
Rated impulse voltage / pollution degree:	6 kV / 3	IEC/EN 60664-1
<b>EMC:</b>		
IEC/EN 61 000-6-4,	IEC/EN 61000-4-1	
Electrostatic discharge (ESD):	8 kV air / 6 kV contact	IEC/EN 61000-4-2
HF irradiation:	10 V / m	IEC/EN 61000-4-3
Fast transients:	2 kV	IEC/EN 61000-4-4
Surge voltages between		
Wires for power supply:	1 kV	IEC/EN 61000-4-5
Between wire and ground:	2 kV	IEC/EN 61000-4-5
HF-wire guided:	10 V	IEC/EN 61000-4-6
Interference suppression:	Limit value class A <sup>*)</sup>	
	*) The device is designed for the usage under industrial conditions (Class A, EN 55011)	
	When connected to a low voltage public system (Class B, EN 55011) radio interference can be generated. To avoid this, appropriate measures have to be taken.	
<b>Degree of protection</b>		
Housing:	IP 40	IEC/EN 60529
Terminals:	IP 20	IEC/EN 60529
<b>Vibration resistance:</b>	Amplitude 0.35 mm	
	Frequency 10 ... 55 Hz, IEC/EN 60068-2-6	
<b>Housing material</b>	Fiberglass reinforced polycarbonate	
	Flame resistant: UL 94 V0	
<b>Base plate:</b>	Aluminum, copper nickle-plated	
<b>Potting compound:</b>	Polyurethane	
<b>Mounting screws:</b>	M5 x 8 mm	

## Technical Data

<b>Fixing torque:</b>	2.5 Nm
<b>Connections control input:</b>	Mounting screws M3 Pozidriv 2 PT
Fixing torque:	0.5 Nm
Wire cross section:	1.5 mm <sup>2</sup> Litze
<b>Connections load circuit:</b>	Mounting screws M4 Pozidriv 1 PT
Fixing torque:	1.2 Nm
Wire cross section:	10 mm <sup>2</sup> wire
<b>Connections monitoring circuit:</b>	Weidmüller - Omnimate Range connecting pair BL 3.50/03 (included in delivery)

### Nominal insulation voltage

Control circuit – load circuit:	4 kV <sub>eff.</sub>
Load circuit – base plate:	4 kV <sub>eff.</sub>
Overvoltage category:	II
<b>Weight</b>	
Without heat sink:	Approx. 100 g
PH 9270.91/___/01:	Approx. 530 g
PH 9270.91/___/02:	Approx. 650 g

### Dimensions

#### Width x height x depth

Without heat sink:	45 x 58 x 35 mm
PH 9270.91/___/01:	45 x 80 x 127 mm
PH 9270.91/___/02:	45 x 100 x 127 mm

### Dimensions

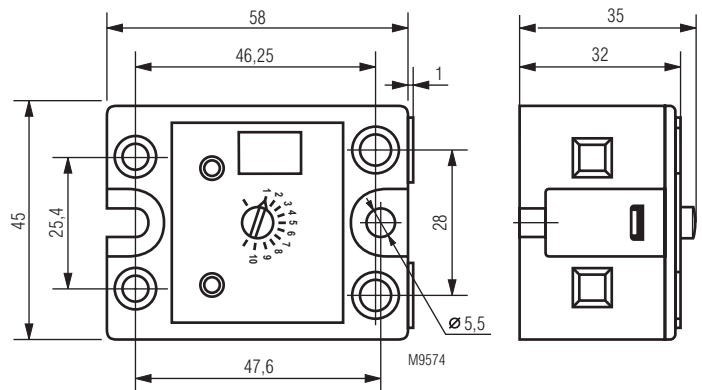

### Accessories

PH 9260-0-12:	Graphite foil 55 x 40 x 0.25 mm to be fitted between device and heat sink, for better heat transmission Article number: 0058395
ZB 9260:	ZB 9260: Adapter for DIN-rail mounting, for devices without heat sink Article number: 0068209

### Standard Type

PH 9270.91 AC 200 ... 480 V	40 A DC 20 ... 32 V
Article number:	0060425
• Load voltage:	AC 200 ... 480 V
• Load current:	40 A
• Auxiliary voltage:	DC 20 ... 32 V
• Alarm output:	PNP, closed circuit operation
• Monitoring:	Under- and overcurrent
• Width:	45 mm



## Notes on Sizing for Selection of a Heat Sink

The heat generated by the load current must be dissipated by a suitable heat sink. It is imperative that the junction temperature of the semiconductor is maintained for all potential environmental temperatures of under 125 °C. For this reason, it is important to keep the thermal resistance between the base plate of the solid-state relay and the heat sink to a minimum.

To protect the solid-state relay effectively from excess heating, a thermally conducting paste or a graphite gasket (see Accessories) should be applied before installation to the base plate of the heat sink between solid-state relay and heat sink.

From the table below, select a suitable heat sink with the next lowest thermal resistance. Thus, it is ensured that the maximum junction temperature of 125 °C is not exceeded. The load current in relation to the environmental temperature can be seen from the table.

## Selection of a Heat Sink

Load current (A)	PH 9270 40 A Thermal resistance (K/W)					
	20	30	40	50	60	70
40	1.2	1.0	0.9	0.7	0.5	0.3
35	1.5	1.3	1.0	0.9	0.7	0.5
30	1.9	1.6	1.4	1.1	0.9	0.7
25	2.4	2.0	1.8	1.5	1.2	0.9
20	3.0	2.7	2.4	2.0	1.7	1.3
15	4.4	3.9	3.4	2.9	2.5	2.0
10	6.9	6.0	5.4	4.7	4.0	3.3
5	14.0	12.9	11.5	10.0	8.6	7.2
	20	30	40	50	60	70
	Ambient-temperature (°C)					

## Application Example

