

**POWERSWITCH**  
**Solid-State Relay / - Contactor**  
**PI 9260**

Translation  
of the original instructions

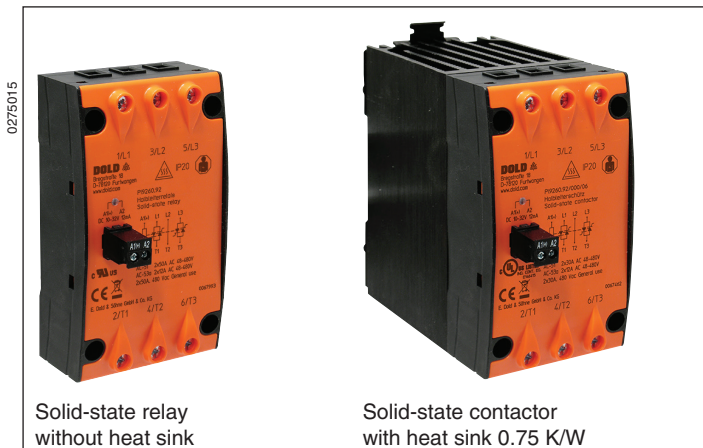

Solid-state relay  
without heat sink

Solid-state contactor  
with heat sink 0.75 K/W

**Your Advantages**

- High switching frequency and long life
- With heat sink for DIN rail mounting
- Silent vibration and shock resistance
- Providing outstanding EMC properties

**Features**

- Three Phase AC solid-state contactor
- Meets generally the requirements of IEC/EN 60947-4-3
- Zero cross or instant-on switching
- 2 anti-parallel thyristors for each pole
- Direct copper bonded (DCB) technology
- Self-lifting box contact terminals
- Peak reverse voltage up to  $\pm 1600V_p$
- Wide range AC and DC input control voltage
- Delivered with integrated heat sink for DIN rail mounting
- IP20 Touch protection

**Product Description**

The solid-state relay PI 9260 was developed for switching resistive and inductive three-phase A.C. current loads, and therefore serves as a replacement for an electromechanical contactor. Both 2-phase and 3-phase controlled versions are available. The DCB technology (direct copper bonding) ensures very good thermal transmission, so that high load currents are possible. The solid-state relay can be mounted on a variety of cooling surfaces. The device is also available as a ready-to-use version with a pre-dimensioned heat sink. This can simply be snapped onto a wide DIN rail. An LED display signals the status of the control input.

**Approvals and Markings**



\*) Depending on variant

**Applications**

**Solid state relays switching at zero crossing:**

For frequent no-wear and no-noise switching of:

- Heating systems
- Cooling systems
- Valves
- Lighting systems

The solid-state relay switches at zero crossing and is suitable for many applications e.g. extrusion machines for plastic and rubber, packaging machines, solder lines, machines in food industry.

**Function Notes**

EMC disturbance during operation has to be reduced by corresponding measures and filters. If several solid-state relays are mounted together sufficient cooling and ventilation has to be provided.

**Notes**

Depending on the application it may be useful to protect the solid-state relay with special superfast semiconductor fuses against shortcircuit.

**Without heat sink**

The solid-state relay can be mounted on existing cooling surfaces. Depending on the load, sufficient ventilation has to be provided.

**With heat sink**

For optimised heat dissipation the solid-state relay can be delivered with special dimensioned heat sinks. Depending on the ambient conditions and the load this helps to select the correct solid-state relay and heat sink. The heat sinks can be clipped on DIN-rail.

**Temperature protection /xx1**

The temperature monitoring ist not stored and has no alarm output. The solid state relay / - contactor automatically switches off when the temperature monitoring is activated and automatically switches on again when the temperature is back in its normal range.

The /xx1 variant is standard for devices with fan.

**Function Diagram**

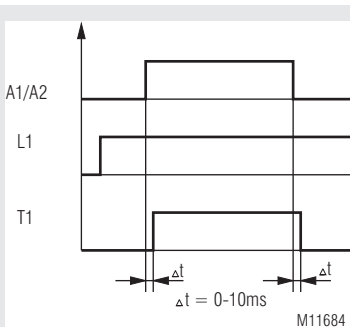

## Circuit Diagrams

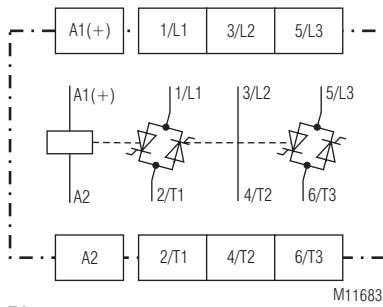

PI 9260.92

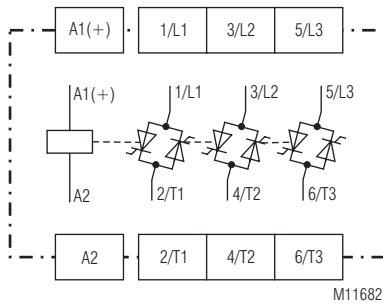

PI 9260.93

## Connection Terminals

Terminal Designation	Signal Designation
A1 (+)	+ / L
A2	- / N
L1, L2, L3	Mains connection
T1, T2, T3	Load output

## Function

The PI 9260 range of three phase AC solid-state relay, better known as Solid-state relay (SSR) is designed with two anti-parallel thyristors for each pole and mounted on a direct copper bonded (DCB) substrate ensuring a high degree of reliability and robustness. The SSR's triggering circuit can be configured to switch resistive loads or inductive loads. Its fast response, high vibration and shock resistance, high current surge capabilities, low electromagnetic interference together with its inherent long life makes the SSR the obvious choice for many applications. Applications would be for heating and cooling systems, lighting displays, process control, plastic injection machines, motorised valves and many more uses.

Two modes of switching are available for the PI9260 range; the zero-cross switching and instant-on switching (also known as random switching). Zero-cross switching is the preferred mode, because the switching of the relay is synchronised with the mains voltage so that the switching is done at the point where the voltage across the relay is nearly zero. This reduces the electrical switching noise. Due to its low input current requirements the relay can be directly operated from most of the logic systems and computer interfaces. An LED indication shows when the relay is activated.

### Two-phase controlled versions – PI 9260.92

In many three-phase applications where the neutral connection is not present in either wye or delta circuits, it is possible to switch on and off loads with only two of the three phases. By means of an internal shunted middle phase, the PI 9260.92 provides all the three phases to the load. Because only two phases are being switched, the internal power loss is reduced and hence more current can be accommodated for a given heat-sink. It has also the advantage of using a smaller heat sink for the same current when compared to a three-switched phase contactor.

### Three-phase controlled version PI 9260.93

This version is used in three-phase applications where all phases have to be switched on and off due to system requirements or in applications having wye connected loads with a neutral conductor. Since the SSR dissipates about 1W per ampere of load current, it is of great importance that an effective means of removing heat from the SSR is provided. Proper choice of heat sink is essential to fully utilise the SSR's current capability for a given ambient temperature. A well ventilated cabinet or panel is recommended. If this point is overlooked overheating will result, causing the SSR to lose control or be permanently damaged. The ratings listed below are valid only when the SSR is mounted alone. If more than one SSR is mounted side by side on the DIN rail then the current derating is necessary to keep the working temperature within acceptable limits. As a rule of thumb, 25% current derating is normally adequate. It is recommended that the spacing between two adjacent SSRs should be at least 30 mm.

## Control Circuit

Control voltage range [V]:	DC 10 ... 32	AC 100 ... 240
Min. Pick-up voltage [V]:	8,0	80
Max. Drop out voltage [V]:	3.0	25
Max. input current [mA]:	12	20 at 230 V AC
Response time - turn on [ms]:	≤ 1.0 + ½ cycle*	≤ 10 + ½ cycle*
Response time - turn off [ms]:	≤ 1.0 + ½ cycle*	≤ 35 + ½ cycle*

\*) ½ cycle delay only when switching at 0-crossing, at instantaneous switching the delay = 0

## Output

Load voltage AC [V]:	24 ... 240	48 ... 480	48 ... 600
Peak reverse voltage [V]:	650	1200	1600
Frequency range [Hz]:	47 ... 63		

Load limit integral I <sup>2</sup> t [A <sup>2</sup> s]:	450	800	1900	5500	6600	18000							
Max. overload current [A] t = 10 ms:	≤ 300	≤ 400	≤ 620	≤ 1050	≤ 1150	≤ 1900							
Leakage current in off state [mA]:	≤ 1.5												
On-state voltage at nominal current [V]	1.0	1.1	1.1	1.1	1.1	1.1							
Rate of rise of off-state voltage [V/μs]:	200	1000	1000	1000	1000	1000							
Rate of rise of current [A/μs]:	100	100	150	150	150	150							
Max. load current at 40°C per pole [A]													
	AC51:	AC53a:	AC51:	AC53a:	AC51:	AC53a:	AC51:	AC53a:	AC51:	AC53a:	AC51:	AC53a:	Number of controlled poles
Without heat sink	20 <sup>1)</sup>	5	30 <sup>1)</sup>	8	50 <sup>1)</sup>	12	60 <sup>1)</sup>	15	70 <sup>1)</sup>	20	80 <sup>1)</sup>	25	2-poles
	20 <sup>1)</sup>	5	30 <sup>1)</sup>	8	50 <sup>1)</sup>	12	60 <sup>1)</sup>	15	70 <sup>1)</sup>	20	80 <sup>1)</sup>	25	3-poles
With heat sink /00	5 <sup>2)</sup>	5											2-poles
	4 <sup>2)</sup>	5											3-poles
With heat sink /07	15 <sup>2)</sup>	5	15 <sup>2)</sup>	8	15 <sup>2)</sup>	12	15 <sup>2)</sup>	15					2-poles
	12 <sup>2)</sup>	5	12 <sup>2)</sup>	8	12 <sup>2)</sup>	12	12 <sup>2)</sup>	12					3-poles
With heat sink /06	20 <sup>2)</sup>	5	30 <sup>2)</sup>	8	30 <sup>2)</sup>	12	30 <sup>2)</sup>	15	30 <sup>2)</sup>	20	30 <sup>2)</sup>	25	2-poles
	20 <sup>2)</sup>	5	20 <sup>2)</sup>	8	20 <sup>2)</sup>	12	20 <sup>2)</sup>	15	20 <sup>2)</sup>	20			3-poles
With heat sink /16					50	12	60 <sup>2)</sup>	15	70	20	80	25	2-poles
									60 <sup>2)</sup>	20	60 <sup>2)</sup>	25	3-poles
					50	12	60 <sup>2)</sup>	15	70	20	80	25	

Current reduction for heat sink /07 from 40°C: three-phase controlled variant = 0.25 A/K; two-phase controlled variant = 0.32 A/K  
 Current reduction for heat sink /06 from 40°C: three-phase controlled variant = 0.32 A/K; two-phase controlled variant = 0.47 A/K

<sup>1)</sup> With UL Recognized approval

<sup>2)</sup> With UL Listed approval

## Thermal Data - Solid-state relay -

Thermal resistance Junction-ambient per pole [K/W]:	13					
Thermal resistance Junction housing per pole [K/W]:	0.6	0.6	0.5	0.35	0.3	0.3
Junction temperature [°C]:	≤ 125					

## General Technical Data

<b>For variant / 16:</b>	Operating voltage fan DC 24 V	
<b>Operating mode:</b>	Continuous operation (Current reduction above 40 °C)	
<b>Temperature range</b>		
Operation:	- 40 ... 80 °C	
Operation for variant /16:	- 10 ... 70 °C	
Storage:	- 40 ... 80 °C	
Relative air humidity:	< 50 % for < +40 °C and < 90 % for < + 20 °C	
<b>Altitude:</b>	1000 m	
<b>Clearance and creepage distances</b>		
Rated impulse voltage / pollution degree:	6 kV / 2	IEC/EN 60664-1
Over voltage category:	III	
<b>EMC:</b>	IEC/EN 61 000-6-4,	IEC/EN 61000-4-1
Electrostatic discharge (ESD):	8 kV air / 6 kV contact	IEC/EN 61000-4-2
HF irradiation:	10 V / m	IEC/EN 61000-4-3
Fast transients:	2 kV	IEC/EN 61000-4-4
Surge voltages control circuit between A1 / A2:	1 kV	IEC/EN 61000-4-5
between output and ground:	2 kV	IEC/EN 61000-4-5
HF-wire guided	10 V	IEC/EN 61000-4-6
Interference suppression:	Limit value class A*) *) The device is designed for the usage under industrial conditions (Class A, EN 55011) When connected to a low voltage public system (Class B, EN 55011) radio interference can be generated. To avoid this, appropriate measures have to be taken.	
<b>Degree of protection:</b>	IP 20	IEC/EN 60529
<b>Vibration resistance:</b>	2 g	IEC/EN 60068-2-6
<b>Housing material:</b>	PBT/PC flame resistant; UL 94 V0	
<b>Base plate:</b>	Nickel plated aluminium	
<b>Mounting screws:</b>	M4 x 20 mm (with conical and plain washers)	
<b>Fixing torque:</b>	1.8 Nm	
<b>Connections load circuit:</b>	Mounting screws M4 Pozidrive PZ 2	
Fixing torque:	1.2 Nm	
Wire cross section:	2 x 1.5 ... 2.5 mm <sup>2</sup> solid or 2 x 2.5 ... 6 mm <sup>2</sup> solid oder 2 x 1.0 ... 2.5 mm <sup>2</sup> stranded wire with sleeve 2 x 2.5 ... 6 mm <sup>2</sup> stranded wire with sleeve 1 x 10 mm <sup>2</sup> stranded wire with sleeve or 1 x 16 mm <sup>2</sup> stranded wire with sleeve	
<b>Connections control circuit:</b>	Mounting screws M3 Pozidrive PZ 1	
Fixing torque:	0.6 Nm	
Wire cross section:	1 x 0.5 ... 2.5 mm <sup>2</sup> solid or 2 x 0.5 ... 1.0 mm <sup>2</sup> solid or 1 x 0.5 ... 2.5 mm <sup>2</sup> stranded wire with sleeve	
<b>Nominal insulation voltage</b>		
Control circuit – load circuit:	4 kV <sub>eff.</sub>	
Load circuit – base plate:	4 kV <sub>eff.</sub>	
Overtoltage category:	III	
<b>Weight</b>		
PI 9260.9X/_ _ _ :	268 g	
PI 9260.9X/_ _ _ /06:	970 g	
PI 9260.9X/_ _ _ /16:	1200 g	

## Dimensions

**Width x height x depth:** 67.5 x 120 x 50 mm

## Standard Type

PI 9260.92/000/06 AC 48 ... 480 V 2 x AC 30 A DC 10 ... 32 V	
Article number:	0067462
• Load voltage:	AC 48 ... 480 V
• Load current AC-51:	2 x 30 A
• <b>Load current AC-53a:</b>	<b>2 x 12 A</b>
• Control voltage:	DC 10 ... 32 V
• With heat sink 0.75 K/W	
• Width:	67.5 mm
PI 9260.93/000/06 AC 48 ... 480 V 3 x AC 20 A DC 10 ... 32 V	
Article number:	0067464
• Load voltage:	AC 48 ... 480 V
• Load current AC-51:	3 x 20 A
• <b>Load current AC-53a:</b>	<b>3 x 12 A</b>
• Control voltage:	DC 10 ... 32 V
• With heat sink 0.75 K/W	
• Width:	67.5 mm

## Variants

PI 9260 .9 / _ _ / _ _	
__	Without heat sink
00	Without heat sink with DIN rail adapter
06	With heat sink 2 x 30 A / 3 x 20 A
07	With heat sink 2 x 20 A / 3 x 12 A
16	With heat sink and fan 2 x 60 A / 3 x 60 A
0	Without temperature protection
1	With temperature protection
0	Switching at zero crossing
1	Instant on switching
0	Standard
1	With high I <sup>2</sup> t-value > 6600 A <sup>2</sup> s
2	With high I <sup>2</sup> t-value > 18000 A <sup>2</sup> s
2	2-poles
3	3-poles

## Ordering example for variants

PI 9260.93 /1 0 0 /06 AC 48 ... 480 V 3 x AC 20 A DC 10 ... 32 V	
	Control voltage
	Load current
	Load voltage
	With heat sink 0.75 K/W
	Without temperature protection
	Switching at zero crossing
	With high I <sup>2</sup> t-value > 6600 A <sup>2</sup> s
	3-poles
	Type

## Further variants

PI9260.92/200/06 AC 48 ... 480V 2 x AC 30 A AC 100 ... 230 V	
Article number:	0067688
Load current AC-51:	2 x 30 A
<b>Load current AC-53a:</b>	<b>2 x 30 A</b>
PI9260.93/000/06 AC 48 ... 480V 3 x AC 20 A AC 100 ... 230 V	
Article number:	0067687
Load current AC-51:	3 x 20 A
<b>Load current AC-53a:</b>	<b>3 x 12 A</b>
PI9260.93/100/06 AC 48 ... 480V 3 x AC 20 A DC 10 ... 32 V	
Article number:	0067686
Load current AC-51:	3 x 20 A
<b>Load current AC-53a:</b>	<b>3 x 20 A</b>

Other variants on request.

## Notes on Sizing for Selection of a Heat Sink

The heat generated by the load current flowing through the SSR has to be removed by a suitably chosen heat sink. It is essential that the junction temperature of the semiconductor is kept below 125 °C for all possible ambient temperatures. It is of paramount importance that the thermal resistance between the SSR base plate and the heat sink is kept to a minimum. A small amount of thermally conductive compound (or a similar interface material) should be applied to the base plate before assembly to the heat sink. The tables shown below can be used as a guide to select a suitable heat sink for various load currents and ambient temperatures situations.

**Input**

Wire connection:

Control circuit: 60°C / 75°C copper conductors only  
AWG 26 - 14 Sol/Str

**Load circuit:**

75°C copper conductors only  
AWG 12 - 10 Sol /Str  
8 - 4 AWG Str  
1.8 Nm

**Note:**

In the user circuit a surge arrester R/CSPD (VZCA2/8) with min. 600 Vac, 50/60Hz, VPR=4000V, type 1 or 2 or 3 with a discharge current not less than 3000 A has to be installed.

Control input 10-32 Vdc:

In the user circuit a surge arrester R/CSPD (VZCA2/8) with min. 50 Vdc, 50/60Hz, VPR=500V, type 1 or 2 or 3 with a discharge current not less than 400 A has to be installed.

Control input 100-240 Vac:

In the user circuit a surge arrester R/CSPD (VZCA2/8) with min. 240 Vdc, 50/60Hz, VPR=2500V, Type 1 or 2 or 3 type 1 or 2 or 3 with a discharge current not less than 2000 A has to be installed.

**More remarks for UL-Listed devices:**

For the use in applications with pollution class 2



Technical data that is not stated in the UL-Data, can be found in the technical data section.

**Selection of a Heat Sink**

a)

Load current (A)	3 Phase SSR Rating 20A/pole Thermal resistance (K/W)					
	20	30	40	50	60	70
20	1.5	1.3	1.1	1.0	0.8	0.6
18	1.7	1.5	1.3	1.1	0.9	0.8
16	2.0	1.7	1.5	1.3	1.1	0.9
14	2.3	2.1	1.8	1.6	1.3	1.1
12	2.8	2.5	2.2	1.9	1.6	1.3
10	3.5	3.2	2.8	2.4	2.1	1.7
8	-	4.1	3.6	3.2	2.7	2.3
6	-	-	-	4.4	3.8	3.2
4	-	-	-	-	-	-
2	-	-	-	-	-	-
	20	30	40	50	60	70
	Ambient temperature (°C)					

e)

Load current (A)	3 Phase SSR Rating 70A/pole Thermal resistance (K/W)					
	20	30	40	50	60	70
70	0.3	0.2	0.2	0.1	0.1	0.1
63	0.3	0.3	0.2	0.2	0.1	0.1
56	0.4	0.3	0.3	0.2	0.2	0.1
49	0.5	0.4	0.4	0.3	0.3	0.2
42	0.7	0.6	0.5	0.4	0.3	0.3
35	0.9	0.8	0.7	0.6	0.5	0.4
28	1.2	1.0	0.9	0.8	0.7	0.5
21	1.7	1.5	1.3	1.1	1.0	0.8
14	2.7	2.4	2.2	1.9	1.6	1.3
7	5.8	5.3	4.7	4.0	3.6	3.0
	20	30	40	50	60	70
	Ambient temperature (°C)					

b)

Load current (A)	3 Phase SSR Rating 30A/pole Thermal resistance (K/W)					
	20	30	40	50	60	70
30	0.7	0.6	0.5	0.4	0.3	0.2
27	0.8	0.7	0.6	0.5	0.4	0.3
24	1.0	0.9	0.8	0.6	0.5	0.4
21	1.2	1.1	0.9	0.8	0.6	0.5
18	1.5	1.4	1.2	1.0	0.8	0.7
15	2.0	1.8	1.5	1.3	1.1	0.9
12	2.7	2.4	2.1	1.8	1.5	1.2
9	3.8	3.4	3.0	2.6	2.2	1.8
6	-	-	-	4.2	3.6	3.0
3	-	-	-	-	-	-
	20	30	40	50	60	70
	Ambient temperature (°C)					

f)

Load current (A)	3 Phase SSR Rating 80A/pole Thermal resistance (K/W)					
	20	30	40	50	60	70
80	0.3	0.2	0.2	0.1	0.1	0.1
72	0.3	0.3	0.2	0.2	0.1	0.1
64	0.4	0.4	0.3	0.2	0.2	0.1
56	0.5	0.4	0.4	0.3	0.2	0.2
48	0.6	0.6	0.5	0.4	0.3	0.2
40	0.8	0.7	0.6	0.5	0.4	0.3
32	1.1	1.0	0.8	0.7	0.6	0.5
24	1.5	1.4	1.2	1.1	0.9	0.7
16	2.5	2.2	2.0	1.7	1.5	1.2
8	5.2	4.7	4.2	3.7	3.2	2.7
	20	30	40	50	60	70
	Ambient temperature (°C)					

c)

Load current (A)	3 Phase SSR Rating 50A/pole Thermal resistance (K/W)					
	20	30	40	50	60	70
50	0.4	0.3	0.2	0.2	0.1	-
45	0.5	0.4	0.3	0.3	0.2	0.1
40	0.6	0.5	0.4	0.4	0.3	0.2
35	0.7	0.6	0.5	0.5	0.4	0.3
30	0.9	0.8	0.7	0.6	0.5	0.4
25	1.2	1.0	0.9	0.8	0.6	0.5
20	1.6	1.4	1.2	1.1	0.9	0.7
15	2.3	2.1	1.8	1.6	1.3	1.1
10	3.7	3.3	2.9	2.5	2.2	1.8
5	-	-	-	-	4.5	4.0
	20	30	40	50	60	70
	Ambient temperature (°C)					

d)

Load current (A)	3 Phase SSR Rating 60A/pole Thermal resistance (K/W)					
	20	30	40	50	60	70
60	0.3	0.3	0.2	0.2	0.1	-
52	0.4	0.3	0.3	0.2	0.2	0.1
48	0.5	0.4	0.4	0.3	0.2	0.2
42	0.6	0.5	0.5	0.4	0.3	0.2
36	0.8	0.7	0.6	0.5	0.4	0.3
30	1.0	0.9	0.8	0.7	0.6	0.4
24	1.3	1.2	1.0	0.9	0.7	0.6
18	2.0	1.8	1.6	1.4	1.1	0.9
12	3.0	2.8	2.5	2.2	1.9	1.6
6	-	-	-	-	4.2	3.5
	20	30	40	50	60	70
	Ambient temperature (°C)					

**Selection of a Heat Sink**

**g)**

Load current (A)	2 Phase SSR Rating 20A/pole Thermal resistance (K/W)					
	20	30	40	50	60	70
20	2.2	1.9	1.7	1.5	1.2	1.0
18	2.5	2.3	2.0	1.7	1.4	1.1
16	3.0	2.6	2.3	2.0	1.7	1.4
14	3.5	3.1	2.8	2.4	2.0	1.7
12	4.3	3.8	3.4	2.9	2.5	2.0
10	5.3	4.7	4.2	3.7	3.1	2.6
8	-	6.2	5.5	4.8	4.1	3.4
6	-	-	-	6.6	5.7	4.8
4	-	-	-	-	-	-
2	-	-	-	-	-	-
	20	30	40	50	60	70

Ambient temperature (°C)

**k)**

Load current (A)	2 Phase SSR Rating 70A/pole Thermal resistance (K/W)					
	20	30	40	50	60	70
70	0.4	0.30	0.3	0.2	0.2	0.1
63	0.5	0.4	0.4	0.3	0.2	0.2
56	0.6	0.6	0.5	0.4	0.3	0.2
49	0.8	0.7	0.6	0.5	0.4	0.3
42	1.0	0.9	0.8	0.6	0.5	0.4
35	1.3	1.2	1.0	0.9	0.7	0.6
28	1.8	1.6	1.4	1.2	1.0	0.8
21	2.5	2.3	2.0	1.7	1.5	1.2
14	4.0	3.7	3.3	2.9	2.4	2.0
7	8.8	7.9	7.0	6.2	5.3	4.5
	20	30	40	50	60	70

Ambient temperature (°C)

**h)**

Load current (A)	2 Phase SSR Rating 30A/pole Thermal resistance (K/W)					
	20	30	40	50	60	70
30	1.0	0.9	0.8	0.6	0.5	0.3
27	1.3	1.0	0.9	0.8	0.6	0.4
24	1.5	1.3	1.1	1.0	0.8	0.6
21	1.9	1.7	1.4	1.2	1.0	0.8
18	2.3	2.1	1.8	1.5	1.3	1.0
15	3.0	2.6	2.3	2.0	1.7	1.4
12	4.0	3.6	3.2	2.7	2.3	1.9
9	5.5	5.1	4.5	3.9	3.3	2.8
6	-	-	-	6.3	5.4	4.5
3	-	-	-	-	-	-
	20	30	40	50	60	70

Ambient temperature (°C)

**l)**

Load current (A)	2 Phase SSR Rating 80A/pole Thermal resistance (K/W)					
	20	30	40	50	60	70
80	0.48	0.41	0.35	0.28	0.22	0.16
72	0.57	0.49	0.42	0.35	0.27	0.20
64	0.68	0.60	0.51	0.43	0.34	0.26
56	0.82	0.73	0.63	0.53	0.43	0.34
48	1.02	0.90	0.79	0.67	0.55	0.44
40	1.29	1.15	1.01	0.87	0.72	0.58
32	1.70	1.52	1.34	1.16	0.98	0.80
24	2.39	2.14	1.90	1.65	1.40	1.16
16	3.77	3.39	3.01	2.63	2.26	1.88
8	7.91	7.13	6.36	5.59	4.82	4.05
	20	30	40	50	60	70

Ambient temperature (°C)

**i)**

Load current (A)	2 Phase SSR Rating 50A/pole Thermal resistance (K/W)					
	20	30	40	50	60	70
50	0.6	0.5	0.4	0.3	0.2	0.1
45	0.7	0.6	0.5	0.4	0.3	0.2
40	0.9	0.8	0.6	0.5	0.4	0.3
35	1.1	1.0	0.8	0.7	0.5	0.4
30	1.4	1.2	1.1	0.9	0.7	0.6
25	1.8	1.6	1.4	1.2	1.0	0.8
20	2.4	2.0	1.9	1.6	1.4	1.0
15	3.5	3.0	2.7	2.4	2.0	1.6
10	5.6	5.0	4.4	3.9	3.3	2.7
5	-	-	-	-	-	6.0
	20	30	40	50	60	70

Ambient temperature (°C)

**j)**

Load current (A)	2 Phase SSR Rating 60A/pole Thermal resistance (K/W)					
	20	30	40	50	60	70
60	0.5	0.4	0.4	0.3	0.2	0.1
52	0.6	0.5	0.5	0.4	0.3	0.2
48	0.8	0.7	0.6	0.5	0.4	0.3
42	0.9	0.8	0.7	0.6	0.5	0.4
36	1.2	1.1	0.9	0.8	0.6	0.5
30	1.5	1.4	1.2	1.0	0.9	0.7
24	2.0	1.8	1.5	1.3	1.1	0.9
18	3.0	2.7	2.4	2.1	1.7	1.4
12	4.8	4.3	3.8	3.3	2.9	2.4
6	-	-	-	-	6.3	5.3
	20	30	40	50	60	70

Ambient temperature (°C)

Dimensions [mm]

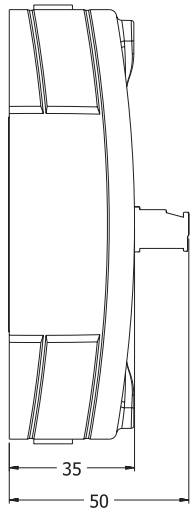
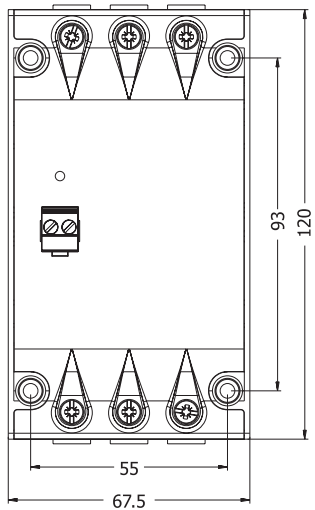

M11707

PI9260.93/\_ \_ \_

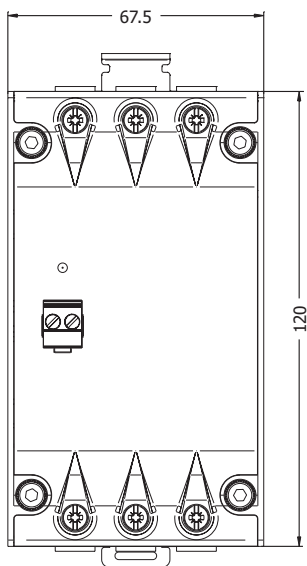
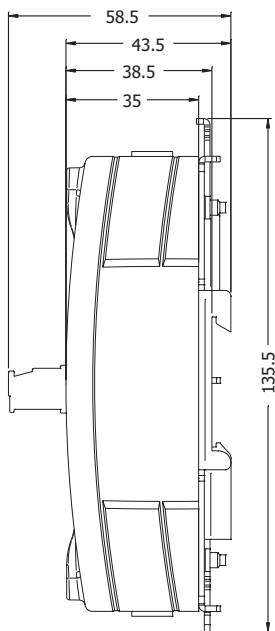
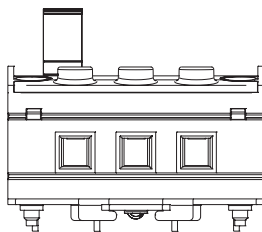

M12531

PI9260.93/\_ \_ \_/00



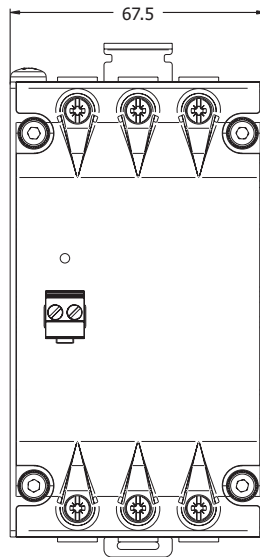
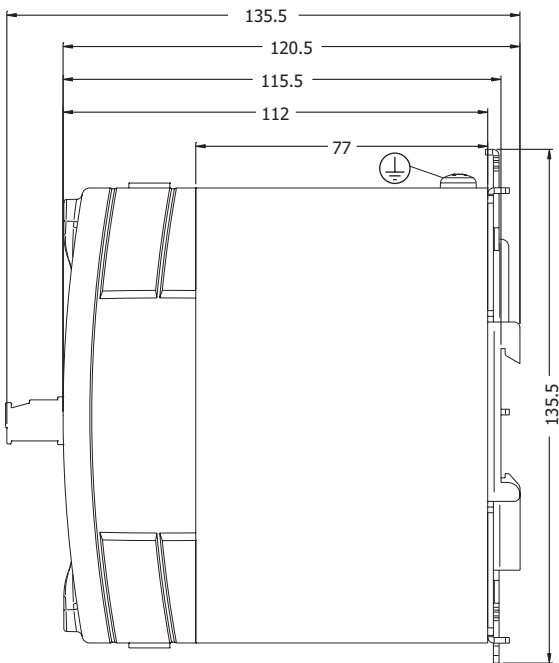
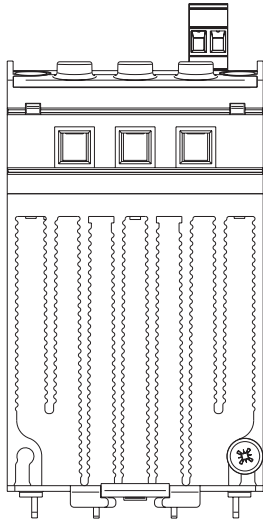

M11705\_a

PI9260.93/\_\_\_/06

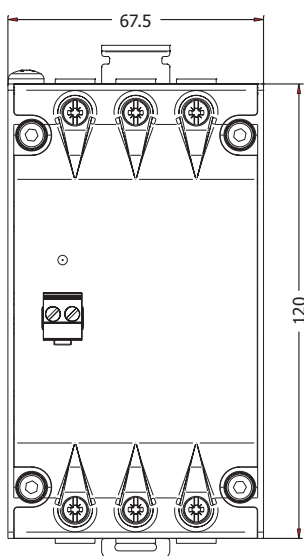
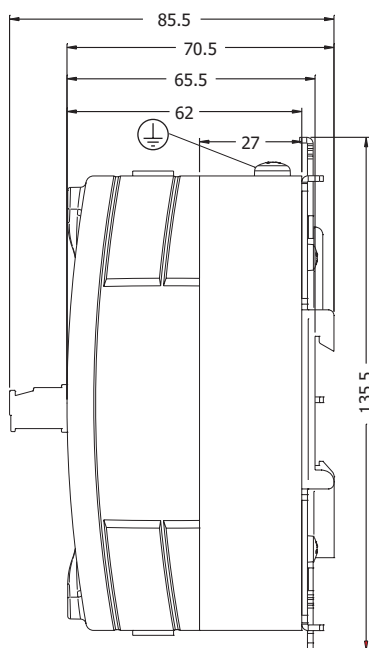
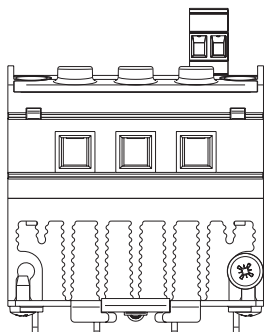

M12532

PI9260.93/\_ \_ \_/07

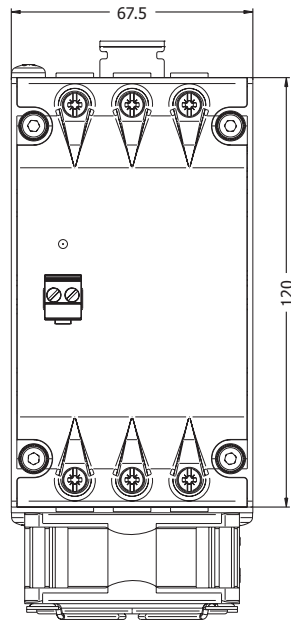
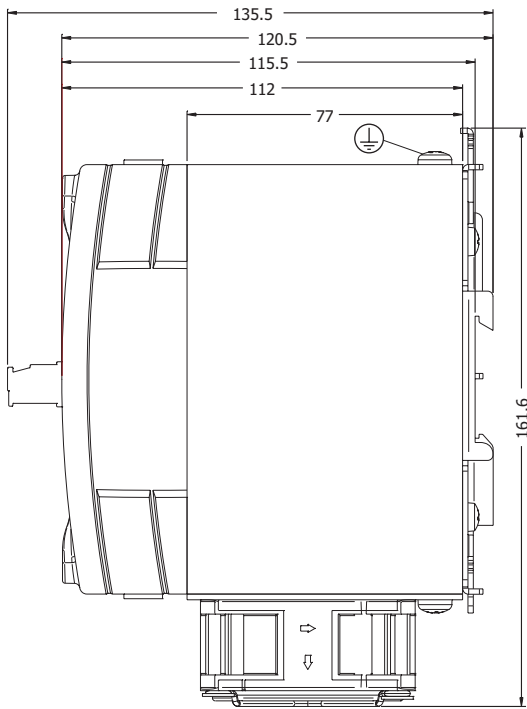
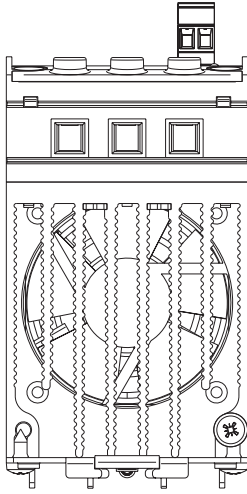

M11706\_a

PI9260.93/\_ \_ \_ /16 (on request)

Typical applications

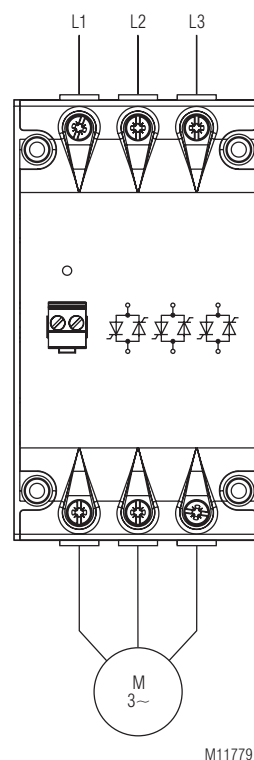
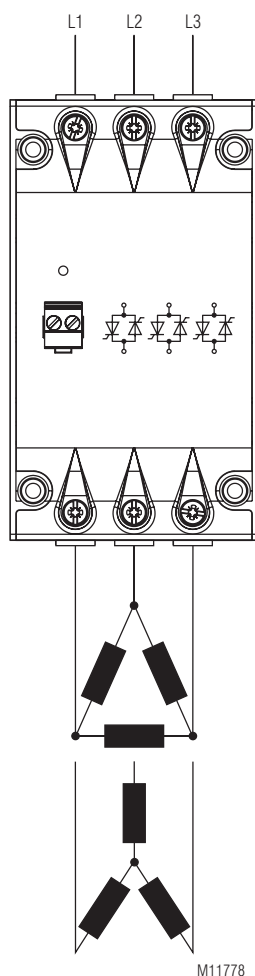
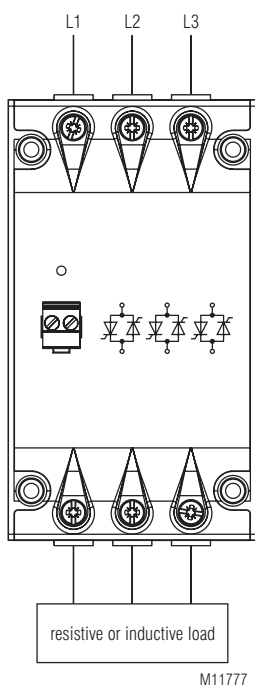
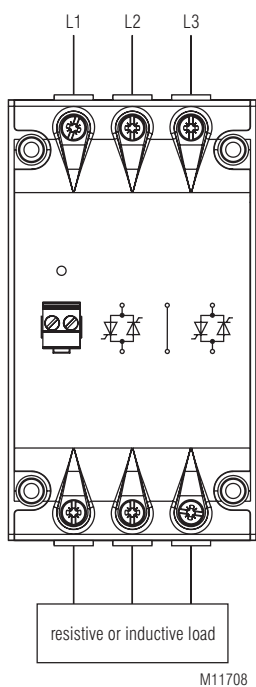

Three phase motor application

