

**Your Advantages**

- Suitable for DC charging stations for electric vehicles acc. to IEC/EN 61851-23:2014/AC:2016-06
- Preventive fire and system protection
- Detection of symmetric and asymmetric insulation faults
- Quick fault localisation through selective earth fault detection to L+ and L-
- Universal application in non-earthed AC, DC, AC/DC networks up to AC max. 250 V or DC max. 300 V
- With connection facility of an external coupling device RL 5898 for voltages up to AC 400 V / DC 500 V or RP 5898 for voltages up to AC 690 V / DC 1000 V
- Very fast reaction time  $\leq 1$  s
- Optimised insulation resistance monitoring also during mains voltage variation
- Self-test every full operating hours
- Easy adjustment of response values and setting parameter via rotational switch and menu display or via Modbus RTU-interface
- Suitable for large leakage capacitances up to 5  $\mu$ F
- Monitoring also with voltage-free mains
- Measuring circuit L(+)/L(-) with broken wire detection (can be switched off)
- Protective conductor PE1/PE2 with broken wire detection (can't be switched off)
- 2 changeover contacts each for insulation failures-Pre-alarm and -alarm each galvanically isolated
- With galvanic separated Modbus RTU interface

**Product Description**

The insulation monitor RN 5897/021 of the VARIMETER IMD family is a solution for optimal insulation monitoring of modern IT systems. The device can be used in the most flexible way for AC, DC and AC/DC systems. Mains areas of applications are non-earthed DC charging stations for electric vehicles with mains voltages up to DC 1000 V. The adjustment of the setting values is simple and user friendly done on 2 rotary switches on the front of the device. Via display and LEDs the measured value, device parameters and device status are indicated easy to read. With a sealable transparent cover the device is protectet against manipulation. The RN 5897/021 has an additional Modbus RTU-interface. All measured values, device states and parameters can be read out, set and parameterized. All functions available on the device can also be operated via Modbus.

**Features**

- Insulation monitoring according to IEC/EN 61557-8
- 2 separate adjustable response thresholds (using e.g. for pre-alarm and Alarm)
- Setting range of 1st response value (Pre-alarm): 1 k $\Omega$  ... 500 k $\Omega$
- Setting range of 2nd response value (alarm): 1 k $\Omega$  ... 500 k $\Omega$
- Energized or de-energized on trip can be selected for indicator relay
- Display for indication of measured value, device parameters and device status
- Automatic and manual device self-test
- Alarm storage selectable
- Protection against manipulation by sealable transparent cover
- External control input for combined test- / reset-button with additional Stop of the measuring function
- 2 wide voltage input for auxiliary voltage
- Width 52.5 mm

**Function Diagram**

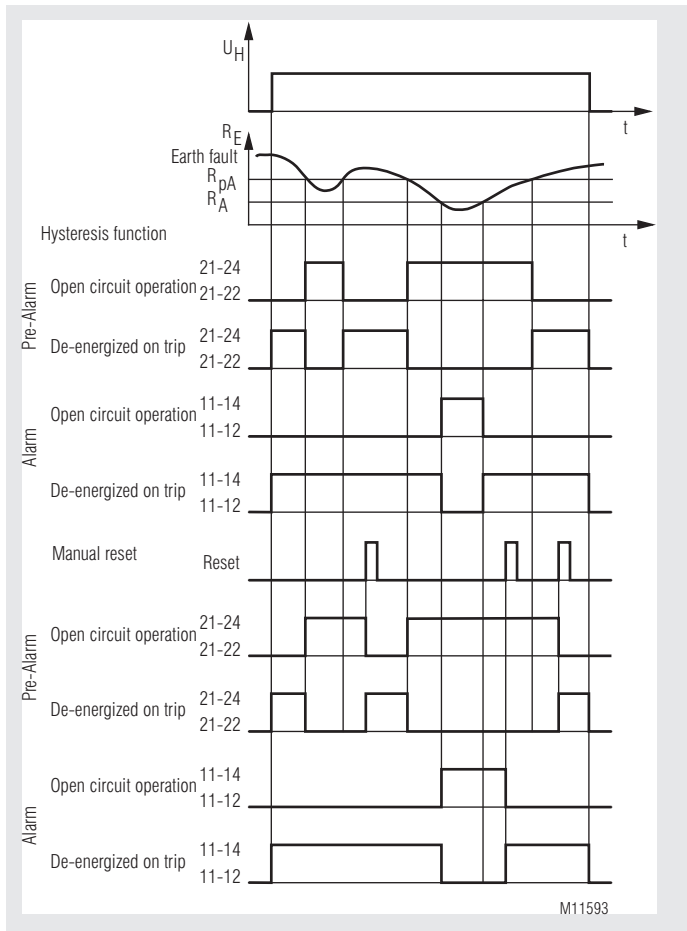

**Approvals and Markings**



**Applications**

- Insulation monitoring of:
- Non-earthed AC, DC, AC/DC networks
  - UPS systems
  - Networks with frequency inverters
  - Battery networks
  - Networks with direct current drives
  - Hybrid and battery-powered vehicles
  - Mobile generator sets
  - DC charging stations for electric vehicles

## Function

The device is supplied with DC auxiliary voltage via terminals A1(+) / A2. Switching on the auxiliary voltage (Power-On) is followed by an internal self-test for 12 s (see „Device test functions“). The test process is visible in the display. After this, measurement of the insulation resistance in the measuring circuits begins and the the colour of the backlight changes into green.

### Measuring circuit

#### (Insulation measurement between terminals L(+)/L(-) and PE1/PE2)

The insulation monitor RN 5897/021 can be operated either with or without coupling device. Max. mains voltage and connection diagrams have to be observed!

If the insulation monitor is operated without coupling device the terminals L(+) and L(-) have to be connected directly to the voltage system to be monitored. and the terminals VSG1/L(+) and VSG2/L(-) each have to be bridged (see also operation with coupling device).

A broken wire detection that can be disabled provides a fault signal if both terminals L(+) and L(-) are not linked by the connected network.

The type of network (AC, DC, 3NAC) has to be selected using the display menu in programming mode or the Modbus.

Also the terminals PE1 and PE2 have to be connected with 2 separate wires to the protective earth. An interruption of a wire also causes a fault signal (see section "Behavior on faulty connection"). The monitoring of the PE connection cannot be de-activated.

To measure the insulation resistance an active measuring voltage with changing polarity is connected between L(+)/L(-) and PE1/PE2. The momentary polarity of the measuring cycle is shown on the display by 2 cursor segments („MP+“ for positive phase and „MP-“ for negative phase). At the end of a measuring cycle the actual insulation resistance is produced and indicated. The actual value is shown on the display and on the Modbus. The relays for alarm K1 and pre-alarm K2 switch when dropping under the adjusted response values. In addition the backlight of the display changes to orange color on pre-alarm or to red color on alarm. An asymmetric earth fault either to „+“ or „-“ is also indicated on the display and the Modbus (only in DC- systems or with a fault on the DC-side of a system).

### Manual reset of fault message

Using the display menu in programming mode or programming via Modbus, the manual reset function for insulation failures can be selected. If manual reset is activated the insulation fault signals of the measuring circuit are stored when dropping under the adjusted response values also if the insulation resistance goes back to healthy state. The minimum value is stored and can be shown on the display and via Modbus. Pressing the „Reset“ button on the front side for 2 s, the alarm signal and the stored minimum value are reset if the actual insulation resistance is in healthy state. The device can also be reset with a Modbus command.

### Indicator relay for insulation fault signal

For the indicator relays K1 (contacts 11-12-14, for alarm) and K2 (contacts 21-22-24, for pre-alarm) the function can be set in programming mode via display menu or Modbus to energized on trip or de-energized on trip when the insulation resistance drops below the adjusted response value. The status of the indicator relays is shown on the display with the two cursor segments "K1" and "K2". When the relay is energized, the corresponding cursor lights up. The status of the indicator relays is also shown via Modbus.

### Disable the measuring function

Using the external control input X1/X2 or a Modbus command the measuring function of the RN 5897/021 can be disabled. This could be used when several isolated voltage systems with individual insulation monitors need to be coupled. The measuring voltage is set to -90V (negative measuring phase) and the evaluation of the measurement is stopped. The output relays switch according to the current measured values. If the measurement is disabled the colour of the display changes to orange and the text "Stop!" is displayed. The stop of the measurement is also shown on the Modbus. Please be aware, only the evaluation of the measurement is stopped and the measuring pulse is interrupted! A high resistive disconnection to PE does not take place (see internal resistance).

## Function

### Broken wire detection

As described in section "Measuring circuit", the measuring circuits L(+)/L(-) and the protective conductors PE1/PE2 are constantly monitored for wire breaks – not only at Power-On or a manual or occasional automatic test. The response time of monitoring is only a few seconds. Broken wire detection between L(+) and L(-) is performed via coupled alternating voltage. This alternating voltage is short-circuited if the terminals are connected to the connected mains at low-resistance. The device detects that the mains to be monitored is properly connected.

Since this broken wire detection is carried out with alternating voltage, large capacitances should be avoided between L(+) and L(-), since the capacitive reactance of these capacitances also short-circuits this alternating voltage. The device would no longer detect a connection fault on L(+)/L(-).

Especially parallel lines should be prevented over larger distances. If larger capacitances between L(+)/L(-) cannot be avoided or if the coupled alternating voltage interferes with the system, the broken wire detection can be de-activated using the display menu in programming mode or programming via Modbus. Monitoring deactivated, monitoring only during device test or continuous monitoring (every 2 minutes for 10 s) are the possible options. If the broken wire detection on L(+)/L(-) is de-activated no AC voltage is injected. The broken wire detection on PE1/PE2 cannot be de-activated.

### Device test functions

Principally, 2 different test functions are implemented: The "self-test" and the "expanded test":

The self-test of the device is performed automatically after Power-On and every full operating hours. It can also be triggered manually at any time by pressing the "Test" button at the device front for 2 s or via Modbus command. With the self-test, contrary to the expanded test, the status of the Indicator relays is not affected; the sequence is as follows:

The display backlight colour changes into orange. For approx. 2 s all pixels and segments of the LCD are shown. After that the text "Test1" comes up and the measuring pulse is switched for approx. 5 s to negative test phase. Additionally the test mode is shown via Modbus. The polarity of the test voltage is also indicated on the display by cursor segments. Within these 5 s the internal measuring circuit is checked for failures. Then the measuring pulse is switched for approx. 5 s to positive test phase and more internal tests take place. If no failures turned up and had been recognized, the measurement continuous. The extended test procedure is started when during or at the end of the above described 12 s self-test the test button is pressed again for 2 s or via a Modbus command. The sequence is similar to the self-test (2 measuring phases of 5 s each) but in addition the output relays go in alarm stated. The display shows "Test2" and via the Modbus the extended test is indicated, too. The test phases of the extended test will be repeated continuously. The extended test can be finished after the first complete sequence (approx. 10 s) by pressing the "reset" button for 2 seconds. The device starts the insulation monitoring again. The extended test can be finished via a Modbus command, too.

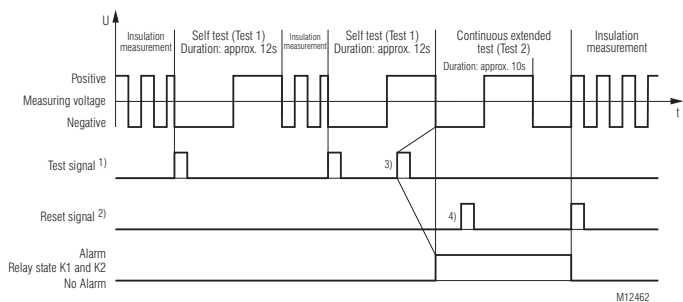

- 1) Test signal:  
Button Test > 2 s or X1/X2 > 1.5 s and < 10 s or Modbus command
- 2) Reset signal:  
Button Reset > 2 s or X1/X2 < 1.5 s or Modbus command
- 3) To initiate the extended test (Test 2) the test signal must be operated within the self test (Test 1) again.
- 4) The reset signal has here no function, as the first complete sequence of extended test (Test 2) is not finished.

## Function

### Behaviour with internal device faults

If internal device faults were detected during the test function, the display backlight changes into red and an error messages (failure code: „Int.1“) is indicated. The indicator relays K1 and K2 switch to the alarm state. The device faults are also indicated via Modbus.

### Behavior on faulty connection

When detecting broken wire on terminals L(+)/L(-), the measurement is disabled. The reaction time could be up to 2 min. The monitoring relays K1 and K2 go in alarm state, the backlight changes to red. The display shows the fault message „L+/L-“. After removing the interruption the fault is automatically reset (max. reaction time up to 2 min) and the measurement of the insulation resistance is continued.

Stored alarm values remain stored. An interruption of the protective earth connections PE1/PE2 causes the same reaction as interrupting the measuring circuit, only the display shows „PE1-PE2“.

Broken wire detection on terminals L(+)/L(-) and PE1/PE2 are also indicated via Modbus.

### External control input

To terminals X1/X2 an external combined Test-/Reset button can be connected. If the terminals X1/X2 > 1.5 s and < 10 s are bridged, the test mode is started. This has the same function as pressing the internal test button. When bridging X1/X2 for < 1.5 s, a stored alarm will be reset. This has the same function as pressing the internal reset button. If X1/X2 is activated for > 10 s, the measuring function is stopped.

The measuring function remains suspended for the duration of the control of X1/X2. The measuring function can also be stopped via Modbus command.

### Connection of an external coupling device

An external coupling device RL 5898 oder RP 5898 can be connected to extend the input voltage range of the monitored voltage system on RN 5897/021. The terminals with the same legend of the insulation monitor and the coupling device (VSG1, VSG2, L(+), L(-)) are connected together. The network to be monitored is connected to terminals L1(+) und L2(-) on the coupling device. Using the display menu in programming mode or programming via Modbus the connection of the coupling device has to be selected and activated. The broken wire detection is active on the terminals L1(+)/L2(-) on the coupling device. A broken wire between coupling device and insulation monitor cannot be detected immediately but the measured values on interruption of 1 or 2 wires between coupling device and insulation monitor are much lower as the real values, which will cause an early response of the device.

### Programming/setting of parameters/set-up of the insulation monitor

The response values for alarm and pre-alarm can be adjusted via 2 rotary switches „R<sub>A</sub>“ and „R<sub>pA</sub>“ on the front of the device. New settings are immediately active and do not require a restart of the unit. More settings can be done with the 3 buttons and the display menu in programming mode or programming via the Modbus. To start the programming mode, the button „Set/ESC“ has to be pressed for approx. 2 s. To avoid unauthorized manipulation, this button as well as the rotary switches „R<sub>A</sub>“ and „R<sub>pA</sub>“ are located behind a sealable transparent cover. When the device changes to programming mode, the measurement is stopped, the display back light changes to orange color and the first parameter is displayed. The programming mode is also indicated via Modbus. To scroll the different parameters, the button „Set/ESC“ has to be pressed short. With the 2 scroll buttons (Scroll-Up „▲“ and Scroll-Down „▼“) the settings can be modified.

The first parameter is the broken wire detection in the measuring circuit „BrWiD“. Possible settings are continuously on („on“), continuously off („oFF“) or only active during self-test. The default is „on“.

The second parameter is alarm memory „Mem.“. Here are 2 options available manual reset („on“) und auto reset („oFF“). The default value is „oFF“.

The third parameter is the relay operation principle „Rel.“ Settings are: de-energized on trip („n.c.“) and energized on trip („n.o.“). The default value is „n.c.“.

## Function

The fourth parameter is the type of network connection „Net“. Selection are AC Network („Ac“), DC-Network („dc“) or 3NAC-Network („3nAc“). The default value is „Ac“.

The device allow the connection of a coupling device, the fifth parameter activates („on“) or de-activates („oFF“) the coupling device. Standard adjustment is de-activates („oFF“).

Parameter six is the setting of the Modbus Baudrate ("kBaud").

Possible setting values are:

| Baudrate<br>kBaud | 1,2 | 2,4 | 4,8 | 9,6 | 19,2 | 38,4 | 57,6 | 115,2 |
|-------------------|-----|-----|-----|-----|------|------|------|-------|
|                   |     |     |     |     |      |      |      |       |

Default setting is 1,2 kBaud

The seventh parameter is the Modbus adress, which can be set between 1 and 99. Default setting is adress 1. To exit the programming mode, the "Set/ESC" button must be pressed for 2 s. The settings are applied and saved permanently. After that, the device performs a restart (like Power-On).

### Programming/setting of parameters/set-up of the insulation monitor (via Modbus)

If the device should be parameterized via Modbus, the rotary switches "R<sub>A</sub>" and "R<sub>pA</sub>" on the front of the device must be set to "Bus".

Then the parameters and setting values can be send via bus to the device. These will be directly applied without a restart of the device.

The Modbus baudrate and adress can only be set locally via the display menu.

### Behaviour at parameter failures

If the rotary switches "R<sub>A</sub>" and "R<sub>pA</sub>" are set to an undefined position (e. g. position 10 - which is not used), the device goes to parameter failure. The backlight changes into red, the indicator relays switch to alarm state and the error message "Param" is indicated. The device fault is also indicated via Modbus. The rotary switches must be set to a defined position to reset the failure. The device will also go to parameter failure if only one rotary switch is set to "Bus".

Both rotary switches must always be set to "Bus".

If setting values and parameters are sent via Modbus to the device while the rotary switches are not set to "Bus", the device will also go to parameter failure. In this case the reset is only possible with a reset command via Modbus.

## Default-Setting of Parameters

| Nr. | Parameter   | Default-Set                                    |
|-----|---|--|
| 1   | Broken wire detect in measuring circuit<br>"Broken Wire Detect" | on   |
| 2   | Storing insulation fault message<br>"Memory"                    | off  |
| 3   | Switching mode of output relays<br>"Relay"                      | n.c. (normally closed)<br>de-energized on trip |
| 4   | Power supply type<br>"Net"                                      | AC   |
| 5   | Ext. coupling device<br>"VSG"                                   | off  |
| 6   | Modbus baud rate<br>"kBaud"                                     | 1.2  |
| 7   | Modbus adress<br>"Adr."   | 1  |

## Circuit Diagram

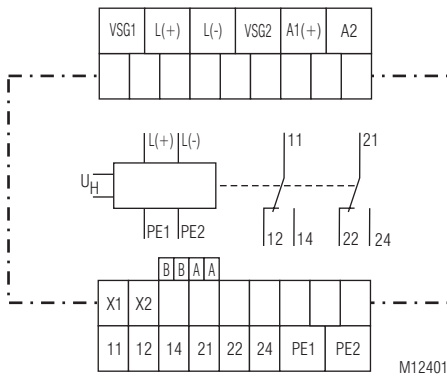

## Connection Terminals

| Terminal designation   | Signal description  |
|------------------------|---|
| A1(+), A2              | Auxiliary voltage AC or DC  |
| L(+), L(-), VSG1, VSG2 | Connection for measuring circuit or<br>Connection for coupling device   |
| PE1, PE2               | Connection for protective conductor   |
| X1, X2                 | Control input<br>(combined external Test- and Reset-input<br>with additional Stop of the measuring<br>function) |
| 11, 12, 14             | Alarm signal relay K1(1 changeover contact)   |
| 21, 22, 24             | Prewarning signal relay K2 (1 changeover<br>contact)  |
| A                      | Modbus signal A   |
| B                      | Modbus signal B   |

## Modbus RTU

For communication between motor controller and a supervising control the Modbus RTU protocol according to Specification V 1.1b3 is used.

## Indicators

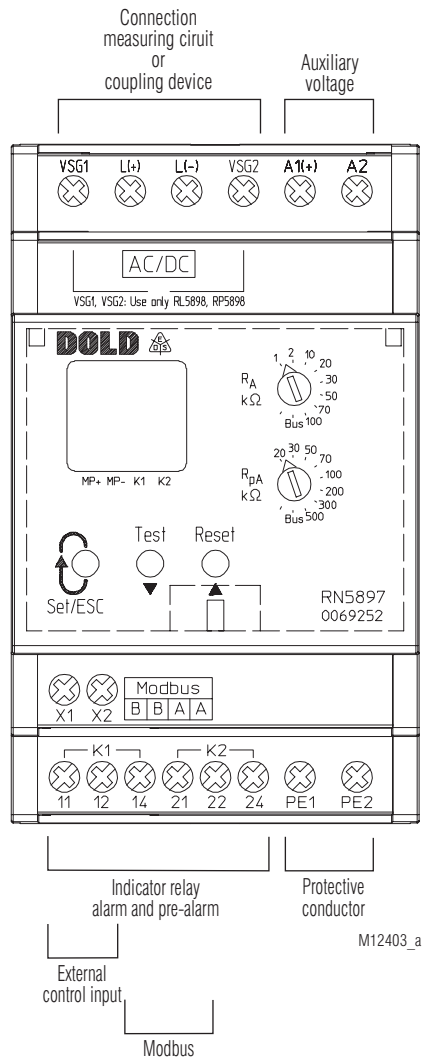

## Indicators

The colour of the backlight indicates the operating status of the device.

- Off:** No auxiliary voltage connected
- Green:** Normal operation (Insulation resistance in healthy state)
- Red:** Alarm (measured value below alarm response value, device failure, connection failure)
- Orange:** Warning (measured value below pre-alarm response value, test mode, Parameter set-up mode)

### Actual value display

The actual insulation resistance „ $R_E$  [k $\Omega$ ]“ is displayed. If the actual value is  $R_E < 10$  k $\Omega$ , the value in k $\Omega$  is displayed with 1 decimal place. With values  $10$  k $\Omega \leq R_E < 500$  k $\Omega$  the display shows the value without decimal place, with values  $500$  k $\Omega \leq R_E < 1$  M $\Omega$  the value is rounded to 10 k $\Omega$ . Insulation resistance values  $1$  M $\Omega \leq R_E < 2$  M $\Omega$  are displayed in M $\Omega$  with one decimal place. If the resistance is  $R_E > 2$  M $\Omega$  the display indicates ---- showing the value is higher than the 2 M $\Omega$ . In a DC Network an asymmetric insulation resistance to „+“ or „-“ is indicated by displaying „ $R_{E+}$  [k $\Omega$ ]“ or „ $R_{E-}$  [k $\Omega$ ]“

By pressing the scroll buttons (Scroll-Up „ $\blacktriangle$ “ und Scroll-Down „ $\blacktriangledown$ “) more measured values can be shown. Another value is the mains voltage on L(+)/L(-). This is indicated with „ $U_N$  [V<sub>AC</sub>]“ or „ $U_N$  [V<sub>DC</sub>]“ in V depending on the type of network and voltage. If the unit is connected single pole to a 3NAC network the mains voltage cannot be measured. With this setting the voltage value is not displayed. When manual reset is selected, the display shows the minimum stored value of the resistance „ $R_M$  [M $\Omega$ ]“ or „ $R_M$  [k $\Omega$ ]“ after the value dropped below the response value also when the value goes back to healthy state. The stored minimum value will only be reset when acknowledging the stored Alarm signal (with the reset button or Modbus command).

Also the firmware version can be displayed.

Other display values are the set alarm value and Pre-warning value („ $R_A$  [k $\Omega$ ]“ und „ $R_{pA}$  [k $\Omega$ ]“). Additionally the firmware-version („Info“) can be requested.

All measured values are provided via Modbus. The actual insulation resistance, and the stored minimum insulation resistance are transmitted with one decimal place. The measured values are transmitted rounded exactly as they are displayed on the device.

For insulation resistances  $R_E > 2$  M $\Omega$  the value 0xFFFF is transmitted.

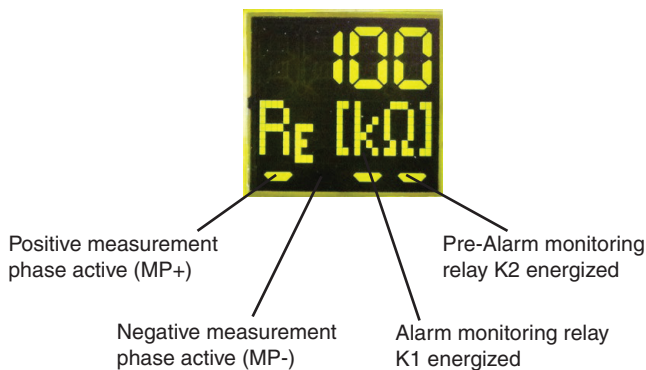









## Indicators

| Display-Indication | Measuring- resp. display value   |
|--------------------|--|
|                    | Insulating resistance in k $\Omega$ resp. M $\Omega$ („----“ complies $R_E \geq 2$ M $\Omega$ )          |
|                    | Asymmetrical insulating resistance in k $\Omega$ against L+ or L- at DC-mains                            |
|                    | Measured mains voltage in V at AC- or DC-mains („----“ indicates invalid voltage value or voltage < 5 V) |
|                    | Stored min. insulating resistance in k $\Omega$ resp. M $\Omega$   |
|                    | Currently set Alarm value "R <sub>A</sub> "  |
|                    | Currently set Pre-warning value "R <sub>pA</sub> "   |
|                    | Latest firmware-version  |

| Display-Indication | Test function  |
|--------------------|--|
|                    | Display-Test   |
|                    | Selftesting (measuring switching, measuring voltage, internal tests) |
|                    | Advanced Test (additional control of indicator relay)                |

| Display-Indication | Function                   |
|--------------------|----------------------------|
|                    | Measuring function stopped |

| Error Indication   |  |   |
|--|--|---|
| Display-Indication   | Failure cause  | Failure recovery  |
|    | Broken wire detection on L(+)/L(-).  | Check measuring circuit L(+) and L (-)  |
|    | Broken wire detection on PE1/PE2.  | Check protective conductor connections PE1 and PE2  |
|    | Rotary switch "R <sub>A</sub> "/"R <sub>pA</sub> " in an undefined position.<br><br>Only one of the two rotary switches "R <sub>A</sub> "/"R <sub>pA</sub> " is set to "Bus".<br><br>Parameters sent via Modbus although the rotary switch "R <sub>A</sub> "/"R <sub>pA</sub> " is not set to "Bus". | Move rotary switch "R <sub>A</sub> "/"R <sub>pA</sub> " to a defined position.<br><br>Set both rotary switches to "Bus".<br><br>Send reset command via Modbus.                  |
|    | Modbus timeout detected  | Lock Modbus timeout, extend timeout time, adjust communication with the master  |
|   | Internal failure detected in test mode   | Press test button again or restart the unit by interrupting the auxiliary supply temporarily. If the fault remains permanent, send device back to manufacturer for examination. |
|  | Faulty calibration values detected in device memory.   | Send device back to manufacturer for recalibration and examination.   |
|  | Internal communication error occurred  | Restart the unit by interrupting the auxiliary supply temporarily. If the fault remains permanent, send device back to manufacturer for examination.                            |
|  | Internal software error occurred   | Restart the unit by interrupting the auxiliary supply temporarily. If the fault remains permanent, send device back to manufacturer for examination.                            |

## Notes



### Risk of electrocution! Danger to life or risk of serious injuries.

- Disconnect the system and device from the power supply and ensure they remain disconnected during electrical installation.
- The display of the voltage is not in real time. The Value on the display is updated at the end of a measuring cycle.
- Determine voltage free status by using appropriate instruments
- The terminals of the control input X1-X2 have no galvanic separation to the measuring circuit L(+) and L(-) and are electrically connected together, therefore they have to be controlled by volt free contacts or bridge. These contacts ore bridges must provide a sufficient separation depending on the mains voltage on L(+)-L(-).
- Please do not connect external voltage to terminals X1/X2. The control must only be made by bridging X1 and X2.
- The coupling unit RL 5898 or RP 5898 must only be used in conjunction with the RP5897/021 on a voltage system and not just by itself.



### Attention!

- Before checking insulation and voltage, disconnect the monitoring device RN 5897/021 from the power source!
- In one voltage system only one insulation monitor can be used. This has to be observed when interconnecting two separate systems..
- Device terminals PE1 and PE2 must always be connected via separate lines to different terminal points of the protective-conductor system.
- The device must not be operated without PE1/PE2 connection!
- If telegrams fail in the bus communication due to EMC interference, grounding the bus cable screening on both sides could be a remedy. With this earthing, attention must be paid to possibly occurring equalizing currents, which could occur with larger potential differences between the bus participants.
- To ensure correct measurement of the insulation resistance, there must be a low-impedance connection ( $\leq 10 \text{ k}\Omega$ ) or a low-impedance internal mains resistance across the source or across the load between the measuring circuit connections L(+) and L(-) (or L1(+) and L2(-) when using the ballast unit).



### Attention!

- The main measuring circuit can be connected with its terminals L(+) and L(-) both to the DC and also AC side of a mixed network; it is done most practically where the primary incoming power supply takes place e.g. with battery networks with connected inverters on the DC side, with Generators/Transformers with connected Rectifiers or inverters on the AC-side. To monitor a 3NAC system the device can be connected single pole, (L(+)) and L(-) are bridged, to the neutral of the 3p4w system. The 3 phases have a low- $\Omega$ ic (approx. 3 – 5  $\Omega$ ) connection via the transformer windings so also insulation failures of the not directly connected phases are detected. Via the display menu in programming mode the correct type of network needs to be selected (see „Connection Examples“).
- If a monitored AC system includes galvanically connected DC circuits (e.g. via a rectifier), an insulation failure on the DC side can only be detected correctly, when a current of min 10 mA can flow via the semiconductor connections.
- If a monitored DC system includes galvanically connected AC circuits (e.g. via an inverter), an insulation failure on the AC side can only be detected correctly, when a current of min 10 mA can flow via the semiconductor connections.
- For the register of the Insulating resistance the value 0xFFFF is transmitted via Modbus if  $R_E > 2 \text{ M}\Omega$ . If no valid mains voltage value was measured or the mains voltage is  $< 5 \text{ V}$ , the value 0xFFFF is transmitted for the register of the measured mains voltage via Modbus. (See Parameter table).

# Running chart

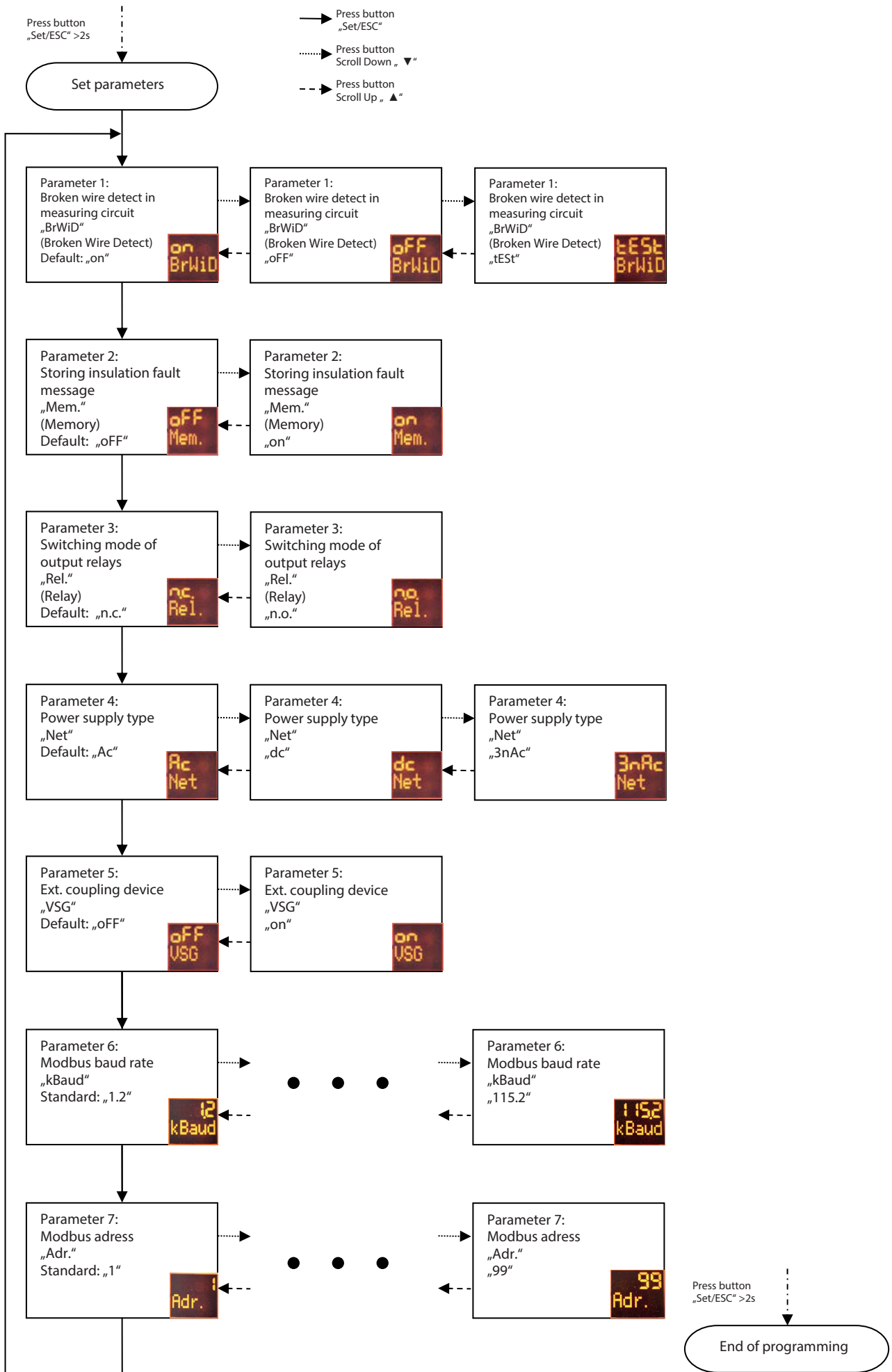

## Technical Data

### Measuring circuit L(+)/L(-) to PE1/PE2 (without coupling device)

|  |   |
|--|---|
| <b>Nominal voltage <math>U_N</math>:</b>             | AC / DC 0 ... 230 V                         |
| <b>Max. voltage range <math>U_N</math>:</b>          | AC 0 ... 250 V<br>DC 0 ... 300 V            |
| <b>Frequency range:</b>                              | DC or 40 ... 1000 Hz                        |
| <b>Max. line capacitance:</b>                        | 5 $\mu$ F                                   |
| <b>Internal resistance (AC / DC):</b>                | > 90 k $\Omega$                             |
| <b>Measuring voltage:</b>                            | Approx. $\pm$ 90 V                          |
| <b>Max. measured current (<math>R_E = 0</math>):</b> | < 1.10 mA                                   |
| <b>Response inaccuracy:</b>                          | $\pm$ 15 % $\pm$ 1.5 k $\Omega$ IEC 61557-8 |
| <b>Response value hysteresis:</b>                    | Approx. + 25 %; min. + 1 k $\Omega$         |

#### On delay

|  |  |
|--|--|
| at $C_E = 1 \mu$ F,                        | response value $\leq$ 100 k $\Omega$ , |
| $R_E$ of $\infty$ to 0.5 * response value: | $\leq$ 1 s                             |
| At $C_E = 1 \mu$ F,                        | response value > 100 k $\Omega$ ,      |
| $R_E$ of $\infty$ to 0.5 * response value: | < 2 s                                  |
| <b>Measuring time</b>                      |  |
| at $C_E = 1 \dots 5 \mu$ F                 | < 5 s                                  |
| <b>Min. operate time:</b>                  | > 0.2 s                                |

#### Response values

##### Adjustable directly on the device

Pre-warning ("R<sub>PA</sub>"):

|              |    |    |    |    |     |     |     |     |
|--------------|----|----|----|----|-----|-----|-----|-----|
| k $\Omega$ : | 20 | 30 | 50 | 70 | 100 | 200 | 300 | 500 |
|--------------|----|----|----|----|-----|-----|-----|-----|

Alarm ("R<sub>A</sub>"):

|              |   |   |    |    |    |    |    |     |
|--------------|---|---|----|----|----|----|----|-----|
| k $\Omega$ : | 1 | 2 | 10 | 20 | 30 | 50 | 70 | 100 |
|--------------|---|---|----|----|----|----|----|-----|

Each adjustable via rotational switches

#### Adjustable via Modbus

|                                 |  |
|---------------------------------|--|
| Pre-warning "R <sub>PA</sub> ": | In the range of 1 ... 500 k $\Omega$ in 1 k $\Omega$ steps |
| Alarm "R <sub>A</sub> ":        | In the range of 1 ... 500 k $\Omega$ in 1 k $\Omega$ steps |

#### Response value broken

wire detection L(+)/L(-): > Approx. 90 k $\Omega$

#### Response value broken

wire detection PE1/PE2: > Approx. 0.5 k $\Omega$

### Meas. circuit L1(+)/L2(-) to PE1/PE2 (with coupling device RL / RP 5898)

|  | RL 5898                                     | RP 5898                           |
|--|---|-----------------------------------|
| <b>Nominal voltage <math>U_N</math>:</b>             | AC 0 ... 400 V<br>DC 0 ... 500 V            | AC 0 ... 690 V<br>DC 0 ... 1000 V |
| <b>Max. max. voltage range <math>U_N</math>:</b>     | AC 0 ... 440 V<br>DC 0 ... 550 V            | AC 0 ... 760 V<br>DC 0 ... 1100 V |
| <b>Frequency range:</b>                              | DC or 40 ... 1000 Hz                        |                                   |
| <b>Max. line capacitance:</b>                        | 5 $\mu$ F                                   |                                   |
| <b>Internal resistance (AC / DC):</b>                | > 240 k $\Omega$                            |                                   |
| <b>Measuring voltage:</b>                            | Approx. $\pm$ 90 V                          |                                   |
| <b>Max. measured current (<math>R_E = 0</math>):</b> | < 0.40 mA                                   |                                   |
| <b>Response inaccuracy:</b>                          | $\pm$ 15 % $\pm$ 1.5 k $\Omega$ IEC 61557-8 |                                   |
| <b>Response value hysteresis:</b>                    | Approx. + 25 %; min. + 1 k $\Omega$         |                                   |

#### On delay

|  |  |
|--|--|
| at $C_E = 1 \mu$ F,                        | response value $\leq$ 100 k $\Omega$ , |
| $R_E$ of $\infty$ to 0.5 * response value: | $\leq$ 1 s                             |
| At $C_E = 1 \mu$ F,                        | response value > 100 k $\Omega$ ,      |
| $R_E$ of $\infty$ to 0.5 * response value: | < 2 s                                  |
| <b>Measuring time</b>                      |  |
| at $C_E = 1 \dots 5 \mu$ F                 | < 5 s                                  |
| <b>Min. operate time:</b>                  | > 0.2 s                                |

#### Response values

##### Adjustable directly on the device

Pre-warning ("R<sub>PA</sub>"):

|              |    |    |    |    |     |     |     |     |
|--------------|----|----|----|----|-----|-----|-----|-----|
| k $\Omega$ : | 20 | 30 | 50 | 70 | 100 | 200 | 300 | 500 |
|--------------|----|----|----|----|-----|-----|-----|-----|

Alarm ("R<sub>A</sub>"):

|              |   |   |    |    |    |    |    |     |
|--------------|---|---|----|----|----|----|----|-----|
| k $\Omega$ : | 1 | 2 | 10 | 20 | 30 | 50 | 70 | 100 |
|--------------|---|---|----|----|----|----|----|-----|

Each adjustable via rotational switches

#### Adjustable via Modbus

|                                 |  |
|---------------------------------|--|
| Pre-warning "R <sub>PA</sub> ": | In the range of 1 ... 500 k $\Omega$ in 1 k $\Omega$ steps |
| Alarm "R <sub>A</sub> ":        | In the range of 1 ... 500 k $\Omega$ in 1 k $\Omega$ steps |

#### Response value broken

wire detection L1(+)/L2(-): > Approx. 500 k $\Omega$

#### Response value broken

wire detection PE1/PE2: > Approx. 0.5 k $\Omega$

#### Max. wire length

between insulation monitor

and coupling device: < 0.5 m

## Technical Data

### Auxiliary voltage input A1(+)/A2

| Nom. Voltage       | Voltage range   | Frequency range                        |
|--------------------|-----------------|--|
| AC/DC 24 ... 60 V  | AC 19 ... 68 V  | 45 ... 400 Hz; DC 48 % W <sup>*)</sup> |
|                    | DC 16 ... 96 V  | W <sup>*)</sup> $\leq$ 5 %             |
| AC/DC 85 ... 230 V | AC 68 ... 276 V | 45 ... 400 Hz; DC 48 % W <sup>*)</sup> |
|                    | DC 67 ... 300 V | W <sup>*)</sup> $\leq$ 5 %             |
| DC 12 ... 24 V     | DC 9.6 ... 30 V | W <sup>*)</sup> $\leq$ 5 %             |

\*) W = Permitted residual ripple of auxiliary supply

#### Nominal consumption:

|                      |             |
|----------------------|-------------|
| DC 12 V, 24 V, 48 V: | Max. 3 W    |
| AC 230 V:            | Max. 3.5 VA |

### Control input X1/X2 for external combined Test-/Reset-Taste

|  |                  |
|--|------------------|
| <b>Current flow:</b>   | Approx. 3 mA     |
| <b>No-load operation voltage X1 to X2:</b>                   | Approx. 12 V     |
| <b>Permissible wire length:</b>                              | < 50 m           |
| <b>Activat. time t for test signal:</b>                      | 1.5 s < t < 10 s |
| <b>Activat. time t for reset signal:</b>                     | t < 1.5 s        |
| <b>Activation time t for Stop of the measuring function:</b> | t > 10 s         |

## Outputs

|   |   |
|---|---|
| <b>Indicator contact:</b>                   | 2 x 1 changeover contact for Alarm (K1) and Pre-Alarm (K2) energized or de-energized on trip (programmable) |
| <b>Thermal current <math>I_{th}</math>:</b> | 4 A   |

#### Switching capacity

|             |                |                  |
|-------------|----------------|------------------|
| to AC 15:   |                |                  |
| NO contact: | 5 A / AC 230 V | IEC/EN 60947-5-1 |
| NC contact: | 2 A / AC 230 V | IEC/EN 60947-5-1 |
| To DC 13:   | 2 A / DC 24 V  | IEC/EN 60947-5-1 |

#### Electrical life

at 5 A, AC 230 V: 1 x 10<sup>5</sup> switching cycles

#### Short circuit strength

|                          |                                       |                  |
|--------------------------|---------------------------------------|------------------|
| <b>max. fuse rating:</b> | 4 A gG / gL                           | IEC/EN 60947-5-1 |
| <b>Mechanical life:</b>  | 50 x 10 <sup>6</sup> switching cycles |                  |

## General Data

|   |  |
|---|--|
| <b>Operating mode:</b>  | Continuous operation   |
| <b>Temperature range</b>  |  |
| Operation:  | - 30 ... + 60 °C<br>(at range 0 ... - 30 °C limited function of the LCD display) |
|   | - 30 ... + 70 °C   |
| Storage:  | $\leq$ 2000 m IEC 60664-1  |
| <b>Altitude:</b>  |  |
| <b>Clearance and creepage distances</b>   |  |
| Rated insulation voltage:   | 300 V  |
| Overvoltage category:   | III  |
| Rated impuls voltage / pollution degree:  |  |
| Measuring circuit L(+)/L(-) to auxiliary voltage A1(+)/A2 and indicator relay contacts K1, K2:              | 4 kV / 2   |
| Auxiliary voltage A1(+)/A2 to indicator relay contacts K1, K2:  | 4 kV / 2   |
| Indicator relay contact K1 to indicator relay contacts K2:  | 4 kV / 2   |
| Bus A, B to measuring circuit L(+)/L(-) and auxiliary voltage A1(+)/A2 and indicator relay contacts K1, K2: | 6 kV / 2   |
| Insulation test voltage   |  |
| Routine test:   | AC 2.5 kV; 1 s<br>AC 4 kV; 1 s   |



| Technical Data                                |  |                  |
|---|--|------------------|
| <b>EMC</b>                                    |  |                  |
| Electrostatic discharge (ESD):                | 8 kV (air)   | IEC/EN 61326-2-4 |
| HF irradiation                                |  | IEC/EN 61000-4-2 |
| 80 MHz ... 1 GHz:                             | 20 V / m   | IEC/EN 61000-4-3 |
| 1 GHz ... 2.7 GHz:                            | 10 V / m   | IEC/EN 61000-4-3 |
| Fast transients:                              | 2 kV   | IEC/EN 61000-4-4 |
| Surge voltage between wires for power supply: | 1 kV   | IEC/EN 61000-4-5 |
| Between wire and ground:                      | 2 kV   | IEC/EN 61000-4-5 |
| HF-wire guided:                               | 20 V   | IEC/EN 61000-4-6 |
| Interference suppression:                     | Limit value classe B   | EN 55011         |
| <b>Degree of protection</b>                   |  |                  |
| Housing:                                      | IP 30  | IEC/EN 60529     |
| Terminals:                                    | IP 20  | IEC/EN 60529     |
| <b>Housing:</b>                               |  |                  |
|   | Thermoplastic with V0 behaviour according to UL subject 94   |                  |
| <b>Vibration resistance:</b>                  |  |                  |
|   | Amplitude 0.35 mm, Frequency 10 ... 55 Hz, IEC/EN 60068-2-6 frequency 2 ... 13.2 Hz, 13.2 ... 100 Hz, acceleration ± 0.7 gn IEC/EN 60068-2-6 10 gn / 11 ms, 3 pulses IEC/EN 60068-2-27 30 / 060 / 04 IEC/EN 60068-1 EN 50005 |                  |
| <b>Shock resistance:</b>                      |  |                  |
| <b>Climate resistance:</b>                    |  |                  |
| <b>Terminal designation:</b>                  |  |                  |
| <b>Wire connection</b>                        |  |                  |
| Cross section:                                | DIN 46228-1/-2/-3/-4<br>0.5 ... 4 mm <sup>2</sup> (AWG 20 - 10) solid or 0.5 ... 4 mm <sup>2</sup> (AWG 20 - 10) stranded wire without ferrules 0.5 ... 2.5 mm <sup>2</sup> (AWG 20 - 10) stranded wire with ferrules        |                  |
| Stripping length:                             | 6.5 mm   |                  |
| <b>Wire fixing:</b>                           |  |                  |
| <b>Wire connection</b>                        |  |                  |
| <b>Bus</b>                                    |  |                  |
| pluggable                                     |  |                  |
| cage-clamp terminal (PC):                     | 0.14 ... 0.5 mm <sup>2</sup> solid or 0.14 ... 0.25 mm <sup>2</sup> stranded ferruled  |                  |
| Insulation of wires or sleeve length:         | 7 mm   |                  |
| <b>Fixing torque:</b>                         | 0.5 Nm   |                  |
| <b>Mounting:</b>                              | DIN rail IEC/EN 60715  |                  |
| <b>Mounting position:</b>                     | Vertical (air flow trough ventilation slots must be ensured)   |                  |
| <b>Weight:</b>                                | Approx. 205 g  |                  |

| Dimensions                     |                   |
|--------------------------------|-------------------|
| <b>Width x height x depth:</b> | 52.2 x 90 x 71 mm |

| Classification to DIN EN 50155         |                     |              |
|--|---------------------|--------------|
| <b>Vibration and shock resistance:</b> | Category 1, Class B | IEC/EN 61373 |
| <b>Service temperature classes:</b>    | OT1 compliant       |              |
| <b>Protective coating of the PCB:</b>  | No                  |              |

| UL-Data   |  |  |
|---|--|--|
| <b>Meas. circuit L1(+)/L2(-) to PE1/PE2 (with coupling device RL / RP 5898)</b> |  |  |

|  | RL 5898                          | RP 5898                          |
|--|----------------------------------|----------------------------------|
| <b>Max. voltage range U<sub>N</sub>:</b> | AC 0 ... 400 V<br>DC 0 ... 500 V | AC 0 ... 600 V<br>DC 0 ... 600 V |

|  |                    |
|--|--------------------|
| <b>Output voltage at L(+)/L(-), VSG1/VSG2:</b> | Max. AC / DC 230 V |
|--|--------------------|

|                            |  |
|----------------------------|--|
| <b>Switching capacity:</b> | Pilot duty C300, R300<br>5A 250Vac<br>2A 30Vdc |
|----------------------------|--|

|                         |   |
|-------------------------|---|
| <b>Wire connection:</b> | 60 °C / 75 °C copper conductors only<br>Torque 0.5 Nm |
|-------------------------|---|

|                            |  |
|----------------------------|--|
| <b>Test specification:</b> | ANSI/UL 60947-1, 5 <sup>th</sup> Edition<br>ANSI/UL 60947-5-1, 3 <sup>rd</sup> Edition<br>CAN/CSA-C22.2 No. 60947-1-13, 2 <sup>nd</sup> Edition<br>CAN/CSA-C22.2 No. 60947-5-1-14, 1 <sup>st</sup> Edition |
|----------------------------|--|

**Info** Technical data that is not stated in the UL-Data, can be found in the technical data section.

| Standard Types   |  |
|--|--|
| RN 5897.12/021/61  | AC/DC 24 ... 60 V  |
| Article number:  | 0069252  |
| • Auxiliary voltage:   | AC/DC 24 ... 60 V  |
| RN 5897.12/021/61  | AC/DC 100 ... 230 V  |
| Article number:  | 0069282  |
| • Auxiliary voltage:   | AC/DC 100 ... 230 V  |
| • Outputs:   | 1 changeover contact for pre-warning<br>1 changeover contact for alarm |
| • Setting range Pre-Alarm:   | 20 kΩ ... 500 kΩ (via rotary switch)                                   |
| • Setting range Pre-Alarm:   | 1 kΩ ... 500 kΩ (via Modbus)   |
| • Setting range Alarm:   | 1 kΩ ... 100 kΩ (via rotary switch)                                    |
| • Setting range Alarm:   | 1 kΩ ... 500 kΩ (via Modbus)   |
| • With Modbus RTU interface  |  |
| • With connection facility of a coupling device RL 5898 or RP 5898 |  |
| • Max. line capacitance:   | 5 μF   |
| • Energized or de-energized on trip                                |  |
| • Selection of type of network                                     |  |
| • Width:   | 52.5 mm  |

### Ordering Example for Variants

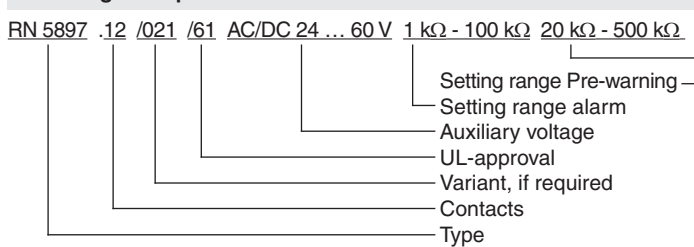

## Accessories

RL 5898/61

Article number: 0068315

- Coupling device for RN 5897.12/021
- Extension of nominal voltage range  $U_N$  to DC 500 V, AC 400 V
- Weight: Approx. 60 g
- Dimensions
  - Width x height x depth: 35 x 90 x 71 mm

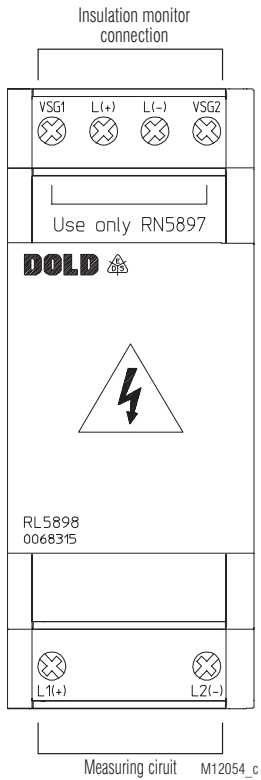

RP5898/61

Article number: 0066944

- Coupling device for RN 5897.12/021
- Extension of nominal voltage range  $U_N$  to DC 1000 V, AC 690 V
- Weight: Approx. 110 g
- Dimensions
  - Width x height x depth: 70 x 90 x 71 mm

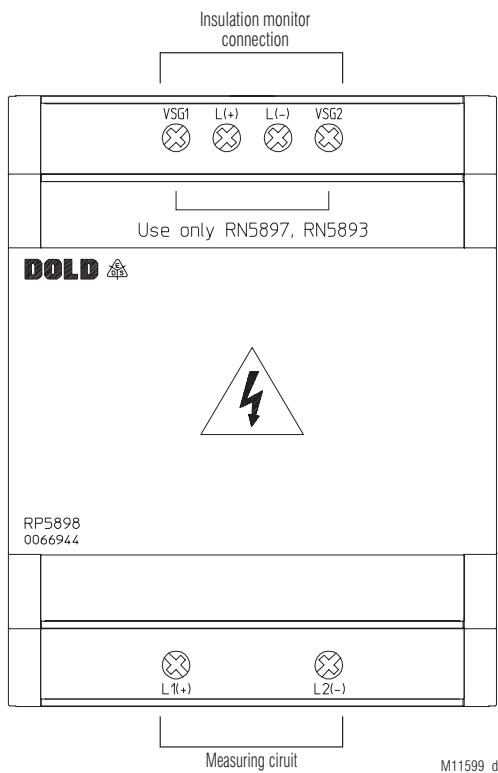

## Accessories

### Flush mounting kit

Order reference: KU 4087-150/0056598

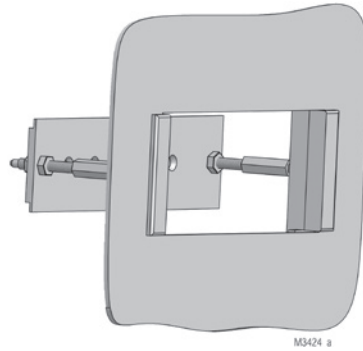

For universal use with:

- R-series devices of 17.5 to 105 mm width
- Easy mounting

## Connection Examples

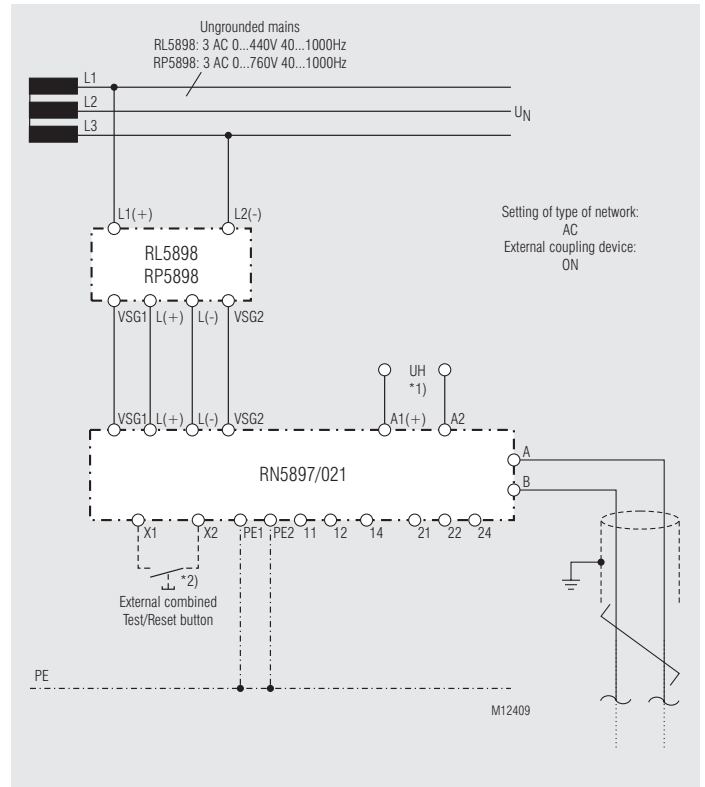
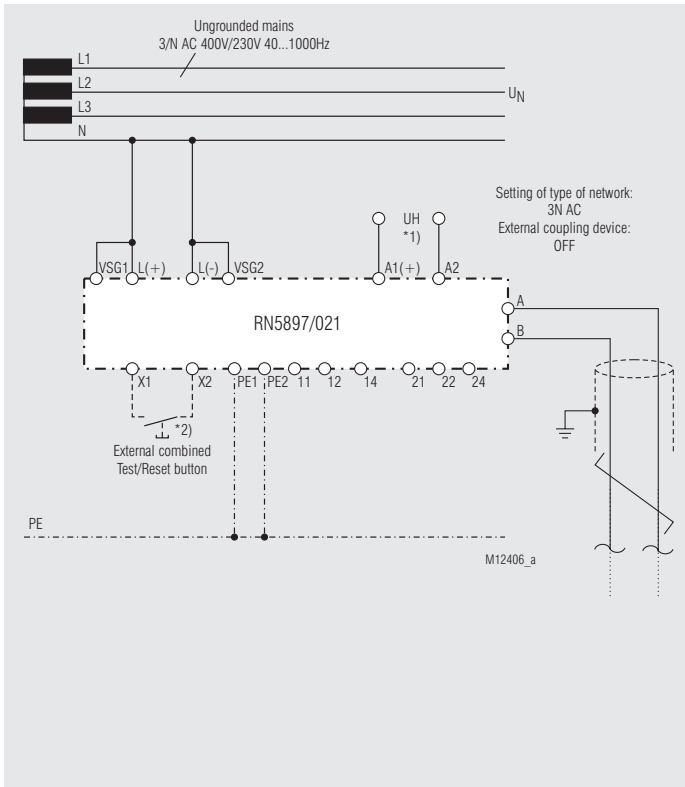

\*1) Auxiliary voltage  $U_H$  (A1(+)/A2) can also be sourced from the monitored voltage system.  
The voltage range of the auxiliary supply has to be taken into account.

\*2) Control input X1/X2 for external combined Test-/Reset-button with Stop of the measuring function:

- Control  $1.5 \text{ s} < t < 10 \text{ s}$ : Test function
- Control  $< 1.5 \text{ s}$ : Reset function
- Control  $> 10 \text{ s}$ : Stop of measuring function

## Connection Examples

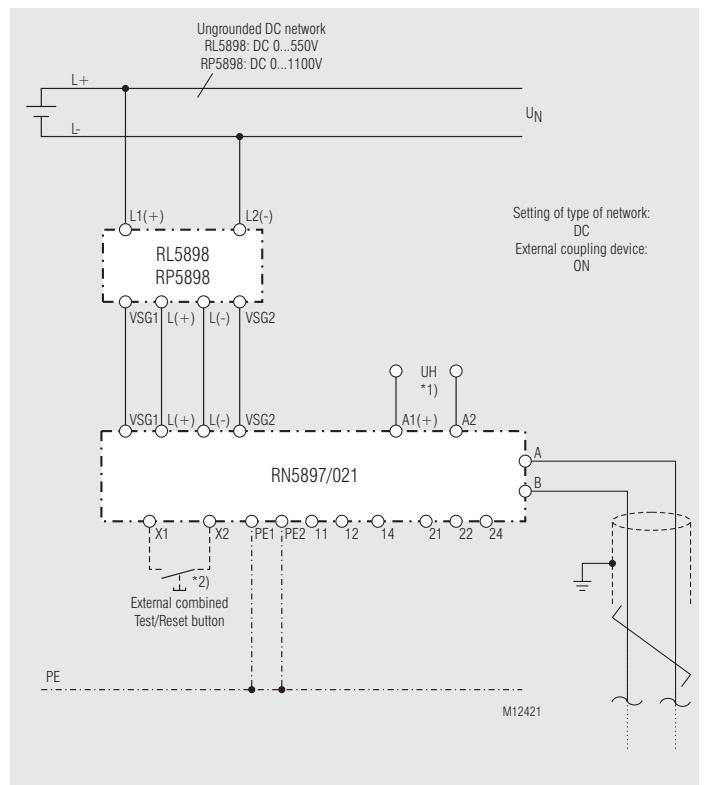
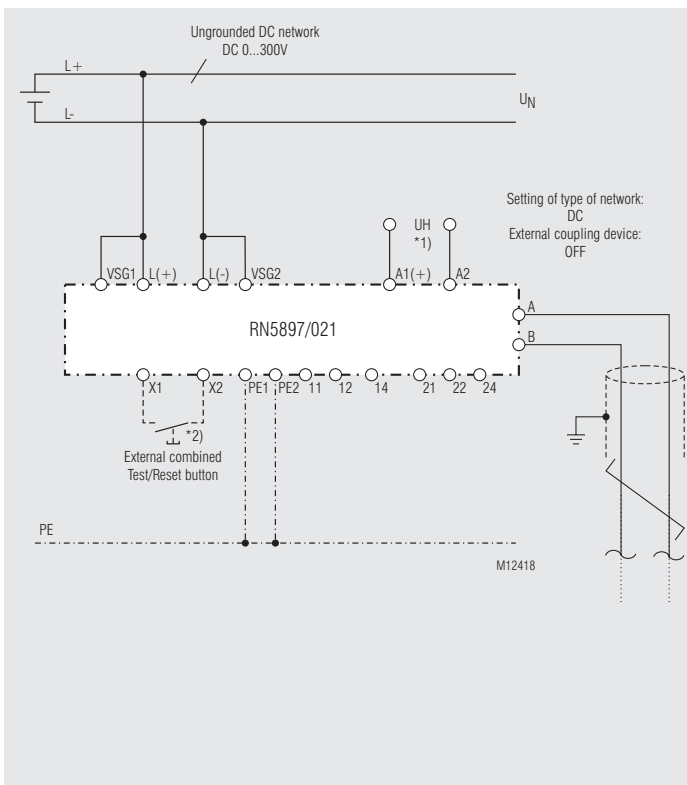
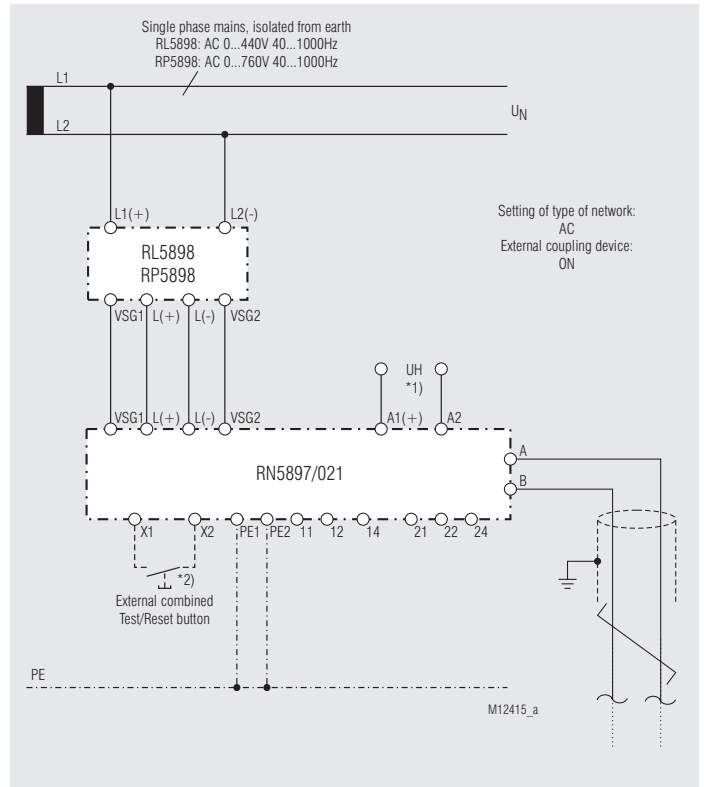
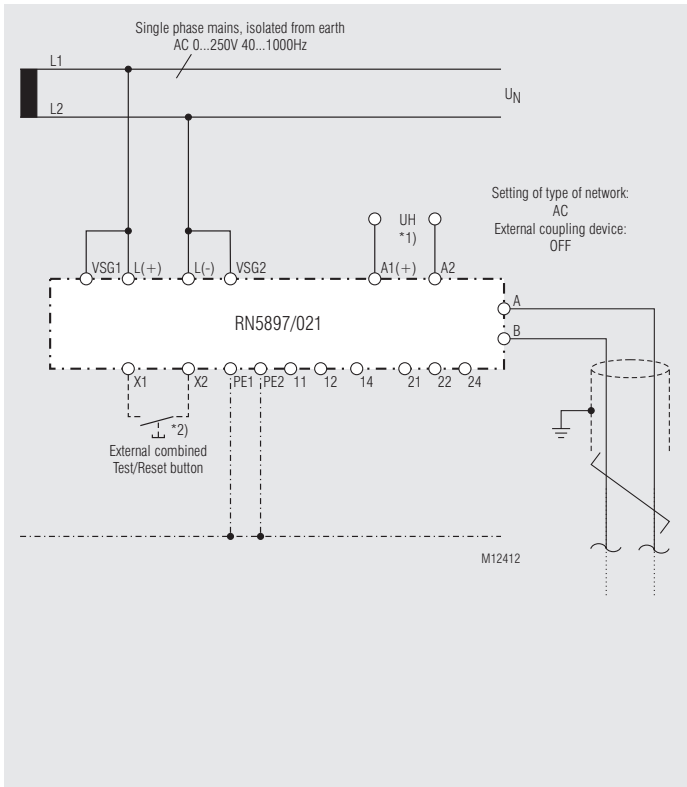

\*1) Auxiliary voltage  $U_H$  (A1(+)/A2) can also be sourced from the monitored voltage system.  
The voltage range of the auxiliary supply has to be taken into account.

\*2) Control input X1/X2 for external combined Test-/Reset-button with Stop of the measuring function:

- Control 1.5 s < t < 10 s: Test function
- Control < 1.5 s: Reset function
- Control > 10 s: Stop of measuring function

### Bus Interface

Protocol Modbus Seriell RTU  
Adress 1 to 99  
Baud rate 1200, 2400, 4800, 9600, 19200, 38400, 57600, 115200 Baud  
Data bit 8  
Stop bit 2  
Parity None

More information about the interface, wiring rules, device identification and communication monitoring can be found in the Modbus user manual.

### Function-Codes

At RN 5897/021 the following function codes are implemented:

| Function-Code | Name                    |
|---------------|-------------------------|
| 0x01          | Read Coils              |
| 0x03          | Read Holding Register   |
| 0x04          | Read Input Register     |
| 0x05          | Write Single Coil       |
| 0x06          | Write Single Register   |
| 0x10          | Write Multiple Register |

### Device configuration

Device configuration data (parameters and setting values from register 42001, as well as the "factory setting" command) are directly stored in the EEPROM in non-volatile memory when writing via Modbus. As the write cycles of an EEPROM are limited, the write operation with these registers or this command must not be cyclic.

**Parameter table**

## Coils

| Register-Address | Protocol-Address | Name                                    | Value range      | Initial value | Description  | Data type | Access rights |
|------------------|------------------|---|------------------|---------------|--|-----------|---------------|
| 1                | 0                | Reset                                   | 0x0000<br>0xFF00 | 0x0000        | No Function<br>Error acknowledgement device error                        | BIT       | Write / read  |
| 2                | 1                | Device reset                            | 0x0000<br>0xFF00 | 0x0000        | No Function<br>Device restart  | BIT       | Write / read  |
| 3                | 2                | Reserved                                | 0x0000<br>0xFF00 | 0x0000        | -  | BIT       | -             |
| 4                | 3                | Factory setting                         | 0x0000<br>0xFF00 | 0x0000        | No Function<br>Factory setting of the parameters                         | BIT       | Write / read  |
| 5                | 4                | Device selftesting                      | 0x0000<br>0xFF00 | 0x0000        | No Function<br>Selftesting   | BIT       | Write / read  |
| 6                | 5                | Fault memory<br>Indicator relay K1 + K2 | 0x0000<br>0xFF00 | 0x0000        | No Function<br>Fault memory acknowledgement<br>Indicator relay K1 and K2 | BIT       | Write / read  |
| 7                | 6                | Reserved                                | 0x0000<br>0xFF00 | 0x0000        | -  | BIT       | -             |
| 8                | 7                | Advanced Test                           | 0x0000<br>0xFF00 | 0x0000        | No Function<br>Advanced Test   | BIT       | Write / read  |
| 9                | 8                | Measuring function<br>stopped           | 0x0000<br>0xFF00 | 0x0000        | Continue measuring function<br>Interrupt measuring function              | BIT       | Write / read  |

**Parameter Table**

## Input Registers

| Register-Address | Protocol-Address | Name            | Value range | Description   | Data type | Access rights |
|------------------|------------------|-----------------|-------------|---|-----------|---------------|
| 30001            | 0                | Device failure  | 0 ... 12    | 0: No failure<br>1: Broken wire detection L(+)/L(-)<br>2: Broken wire detection PE1/PE2<br>3: Internal failure detected in test mode (Int. 1)<br>4: Parameter failures (Incorrect setting of potentiometers on the device)<br>9: Communication fault Modbus<br>10: Checksum failure EEPROM (Int. 2)<br>11: Internal communication fault (Int. 3)<br>12: Internal error 4 (Int. 4) | UINT16    | Read          |
| 30002            | 1                | State of device | 0 ... 5     | 0: Device initialize<br>1: Device is ready and in measuring mode<br>2: Device in error mode<br>3: Device in selftesting<br>4: Device in advanced test<br>5: Measuring function stopped  | UINT16    | Read          |
| 30003            | 2                | Device flags    | 0 ... 3     | Bit 0: Indicator relay K1 energized<br>Bit 1: Indicator relay K2 energized  | UINT16    | Read          |

| Register-Address | Protocol-Address | Name                               | Value range                           | Description  | Data type | Access rights |
|------------------|------------------|------------------------------------|---------------------------------------|--|-----------|---------------|
| 32001            | 2000             | Insulating resistance              | 0 ... 20000, 65535                    | In 1/10 kΩ   | UINT16    | Read          |
| 32002            | 2001             | Asymmetrical insulating resistance | 1,2,4                                 | Bit 0: Resistance is symmetrical<br>Bit 1: Asymmetrical against L+<br>Bit 2: Asymmetrical against L- | UINT16    | Read          |
| 32003            | 2002             | Measured mains voltage             | 0 ... 300, 65535<br>0 ... 1000, 65535 | Without VSG in V<br>With VSG in V  | UINT16    | Read          |
| 32004            | 2003             | Stored min. insulating resistance  | 0 ... 20000, 65535                    | In 1/10 kΩ   | UINT16    | Read          |

**Parameter Table**

## Holding Registers

| Register-Address | Protocol-Address | Name            | Value range                  | Initial value | Description  | Data type | Access rights |
|------------------|------------------|-----------------|------------------------------|---------------|--|-----------|---------------|
| 40001            | 0                | Control word 1  | 0 ... 65535                  | 0             | Bit 0 = Reset<br>Bit 1 = Device reset<br>Bit 2 = Reserved<br>Bit 3 = Factory settings<br>Bit 4 = Device selftesting<br>Bit 5 = Fault memory acknowledgement indicator relay K1 and K2<br>Bit 6 = Reserved<br>Bit 7 = Advanced test<br>Bit 8 = Measuring function stopped | UINT16    | Write / read  |
| 40002            | 1                | Timeout release | 0 ... 1                      | 0             | Bit 0 = Enable   | UINT16    | Write / Read  |
| 40003            | 2                | Timeout         | 100 ... 10000<br>0 ... 10000 | 1000          | Timeout Value in ms (write)<br>Timeout Value in ms (read)  | UINT16    | Write / Read  |

| Register-Address | Protocol-Address | Name  | Value range | Initial value | Description   | Data type | Access rights |
|------------------|------------------|---|-------------|---------------|---|-----------|---------------|
| 42001            | 2000             | Broken wire detect in measuring circuit                 | 1,2,4       | 1             | Bit 0 = On<br>Bit 1 = Off<br>Bit 2 = Only during the device selftesting | UINT16    | Write /Read   |
| 42002            | 2001             | Storing insulation fault message indicator relay K1+ K2 | 0 ... 1     | 0             | 0 = Off<br>1 = On   | UINT16    | Write /Read   |
| 42003            | 2002             | Switching mode of output relays indicator relay K1+ K2  | 0 ... 1     | 0             | 0 = De-energized on trip<br>1 = Energized on trip                       | UINT16    | Write /Read   |
| 42004            | 2003             | Power supply type                                       | 1,2,4       | 1             | Bit 0 = AC mains<br>Bit 1 = DC mains<br>Bit 2 = 3N AC mains             | UINT16    | Write /Read   |
| 42005            | 2004             | Reserved  | -           | 1             |   | UINT16    | Write /Read   |
| 42006            | 2005             | Response value indicator relay K1                       | 1 ... 500   | 500           | Response value indicator relay K1 in k $\Omega$                         | UINT16    | Write /Read   |
| 42007            | 2006             | Response value indicator relay K2                       | 1 ... 500   | 500           | Response value indicator relay K2 in k $\Omega$                         | UINT16    | Write /Read   |
| 42008            | 2007             | Coupling device   | 1,2         | 1             | Bit 0 = Off<br>Bit 1 = RL 5898 or RP 5898                               | UINT16    | Write /Read   |