

Your Advantages

- Insulation monitoring according to IEC/EN 61557-8
- Suitable for DC charging stations for electric vehicles acc. to IEC/EN 61851-23:2014/AC:2016-06
- Universal application in non-earthed AC, DC, AC/DC networks up to AC max. 250 V or DC max. 300 V
- With connection facility of an external coupling device RL 5898 for voltages up to AC 400 V / DC 500 V or RP 5898 for voltages up to AC 690 V / DC 1000 V
- Extended operating temperature range of - 40 ... + 70 °C
- Very fast reaction time ≤ 1 s
- Optimised insulation resistance monitoring also during mains voltage variation
- Self-test every full operating hours
- Preventive fire and system protection
- Detection of symmetric and asymmetric insulation faults
- Universal application in non-earthed AC, DC, AC/DC networks
- Easy adjustment of response value and setting parameter via rotational switch
- Suitable for large leakage capacitances up to 5 µF
- Monitoring also with voltage-free mains
- Measuring circuit L(+)/L(-) with broken wire detection (can be switched off)
- Protective conductor PE1/PE2 with broken wire detection (can't be switched off)

Product Description

The insulation monitor RN 5897/240 of the VARIMETER IMD family is a solution for optimal insulation monitoring of modern IT systems. The device can be used in the most flexible way for AC, DC and AC/DC systems. The setting of the parameters and the switching values is done by simple and operator friendly rotational switches on front of the device. The operating status is indicated user friendly via a multicolour LED. With a sealable transparent cover the device is protectet against manipulation.

Circuit Diagram

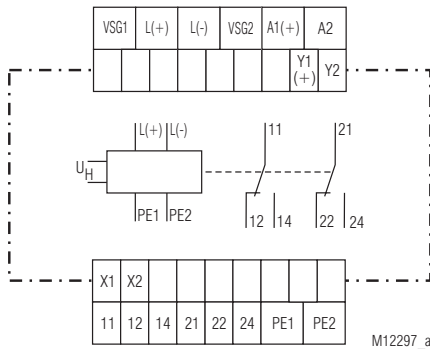

Connection Terminals

Terminal designation	Signal description
A1(+), A2	Auxiliarx voltage AC or DC
L(+), L(-), VSG1, VSG2	Connection for measuring circuit resp. connection for coupling device
PE1, PE2	Connection for protective conductor
X1, X2	Control input (combined external Test- and Reset-input with additional Stop of the measuring function)
Y1(+), Y2	Semiconductor output (Open Collector) with PWM-signal to indicate the actual insulation resistance
11, 12, 14	Alarm signal relay K1(1 changeover contact)
21, 22, 24	Device fault indicator relay K2 (1 changeover contact)

Features

- Setting range of 2nd response value (alarm): 1 kΩ ... 500 kΩ
- 1 changeover contacts each for insulation failures alarm and device failures
- Energized or de-energized on trip can be selected for indicator relay
- With multicolour status LED to indicate the state of operation.
- Automatic and manual device self-test
- Alarm storage selectable
- Protection against manipulation by sealable transparent cover
- External control input for combined test- / reset-button with additional stop of the measuring function
- With semiconductor output to indicate the insulation resistance (PWM)
- 3 wide voltage input for auxiliary voltage
- Width 52.5 mm

Approvals and Markings



¹⁾ RN 5897 only

Applications

- Insulation monitoring of:
- Non-earthed AC, DC, AC/DC networks
 - DC charging stations for electric vehicles
 - UPS systems
 - Networks with frequency inverters
 - Battery networks
 - Networks with direct current drives
 - Hybrid and battery-powered vehicles
 - Mobile generator sets

Function

The device is supplied with DC auxiliary voltage via terminals A1(+) / A2. Switching on the auxiliary voltage (Power-On) is followed by an internal self-test for 12 s (see „Device test functions“). The test process is visible with the status LED. After this, measurement of the insulation resistance in the measuring circuits begins and the status LED changes into green.

Measuring circuit

(Insulation measurement between terminals L(+)/L(-) and PE1/PE2)

The insulation monitor RN 5897/240 can be used both with ballast (VSG) and without VSG. Max. mains voltage and connection diagrams have to be observed!

If the insulation monitor is operated without coupling device the terminals L(+) and L(-) have to be connected directly to the voltage system to be monitored. and the terminals VSG1/L(+) and VSG2/L(-) each have to be bridged (see also operation with coupling device).

A broken wire detection that can be disabled provides a fault signal if both terminals L(+) and L(-) are not linked by the connected network.

The type of the voltage system or the connection method (AC, DC, 3NAC) has to be correctly adjusted on the rotational switch "UN".

Also the terminals PE1 and PE2 have to be connected with 2 separate wires to the protective earth. An interruption of a wire also causes a fault signal (see section "Behavior on faulty connection"). The monitoring of the PE connection cannot be de-activated.

To measure the insulation resistance an active measuring voltage with changing polarity is connected between L(+) and L(-) and PE1/PE2.

At the end of a measuring cycle the actual insulation resistance is produced and indicated. The relay for alarm K1 switch when dropping under the adjusted response value. In addition the status LED lights up red on alarm.

Manual reset of fault message

With the 2-section rotational switch "UN", manual or auto reset of the alarm can be selected. If manual reset is activated the insulation fault signal of the measuring circuit is stored when dropping under the adjusted response value also if the insulation resistance goes back to healthy state. Pressing the „Reset“ button on the front side for 2 s, the alarm signal is reset if the actual insulation resistance is in healthy state.

Indicator relay for insulation fault and device failure

The function of the relays K1 (contacts 11-12-14 for alarm) and K2 (contacts 21-22-24) can be altered between energised on trip (relay n.o.) or de-energised on trip (relay n.c.). When energised on trip the relays energize when the value drops below the setting or at device failure, when de-energised on trip, the relays de-energize when the value drops below the setting or at device failure.

Semiconductor output to indicate the insulation resistance

On terminals Y1(+)/Y2 a galvanically separated semiconductor output is available as PWM (Pulse width modulated) signal that shows the actual insulation resistance. It is an opto-coupler output with open collector. This means that an external circuit is required (ext. supply voltage and pull up/down resistor).

Disable the measuring function

Using the external control input X1/X2 the measuring function of the RN 5897/240 can be disabled. This could be used when several isolated voltage systems with individual insulation monitors need to be coupled.

The measuring voltage is set to -90V (negative measuring phase) and the evaluation of the measurement is stopped. The status of the output relays is frozen and not changed any more. If the measurement is disabled the status LED flashes continuously orange. Please be aware, only the evaluation of the measurement is stopped and the measuring pulse is interrupted! A high resistive disconnection to PE does not take place (see internal resistance).

Function

Broken wire detection

As described in section "Measuring circuit", the measuring circuits L(+)/L(-) and the protective conductors PE1/PE2 are constantly monitored for wire breaks – not only at Power-On or a manual or occasional automatic test. The response time of PE1/PE2 monitoring is only a few seconds. The response time of monitoring of L(+)/L(-) can be up to approx. 2 min. Broken wire detection between L(+) and L(-) is performed via coupled alternating voltage. This alternating voltage is short-circuited if the terminals are connected to the connected mains at low-resistance. The device detects that the mains to be monitored is properly connected.

Since this broken wire detection is carried out with alternating voltage, large capacitances should be avoided between L(+) and L(-), since the capacitive reactance of these capacitances also short-circuits this alternating voltage. The device would no longer detect a connection fault on L(+)/L(-).

Especially parallel lines should be prevented over larger distances.

If larger capacitances between L(+)/L(-) cannot be avoided or if the coupled alternating voltage interferes with the system, the broken wire detection can be de-activated on the 2-section rotational switch "Rel. /VSG". It can be altered between continuously disabled (Broken Wire Detect OFF), or continuously enabled (Broken Wire Detect ON) for 10 seconds every 2 minutes. If the broken wire detection on L(+)/L(-) is de-activated no AC voltage is injected. The broken wire detection on PE1/PE2 cannot be de-activated.

Device test functions

Principally, 2 different test functions are implemented: The "self-test" and the "expanded test":

The self-test of the device is performed automatically after Power-On and every full operating hours. It can also be triggered manually at any time by pressing the "Test" button at the device front for 2 s.

With the self-test, contrary to the expanded test, the status of the Indicator relays is not affected; the sequence is as follows:

The self test is indicated by the status LED with flash code 1 in orange colour. First the negative measuring pulses is activated for about 5 s and the internal measuring circuit is checked on failures. Then the positive measuring pulse is activated for about 5 s and more internal tests are performed. If no failures are detected, the normal measurement continuous. The extended test is started, when during or at the end of above procedure (12 s) the button "Test" is pressed again for 2 s.

The procedure is the same as above (2 measuring phases with 5 sec each) but in addition the output relays K1 and K2 go into alarm state and the PWM on the semiconductor output drops to the lowest value. The Status LED shows flash code 2 in orange colour. The test phases will be continuously repeated. The extended test can be finished after the first complete sequence (approx. 10 sec) by pressing the "reset" button for 2 seconds. The device starts the insulation monitoring again.

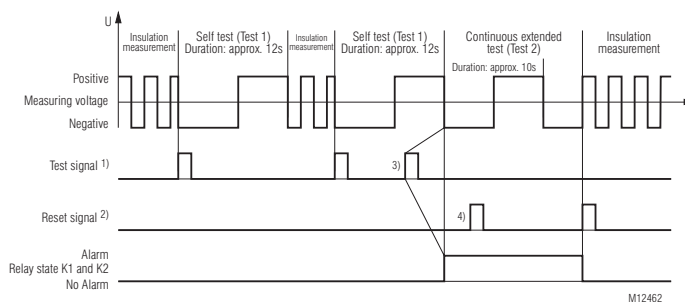

- 1) Test signal: Button Test > 2 s or X1/X2 > 1.5 s and < 10 s
- 2) Reset signal: Button Reset > 2 s or X1/X2 < 1.5 s
- 3) To initiate the extended test (Test 2) the test signal must be operated within the self test (Test 1) again.
- 4) The reset signal has here no function, as the first complete sequence of extended test (Test 2) is not finished.

Function

Behaviour with internal device faults

If internal device faults were detected during the test function, the status LED flashes permanently red. The indicator relay K2 switch to the alarm state.

Behavior on faulty connection

When detecting broken wire on terminals L(+)/L(-), the measurement is disabled. The reaction time could be up to 2 min. The monitoring relay K2 goes in alarm state, the status LED shows flash code 1 in red colour. After removing the interruption the fault is automatically reset (max. reaction time up to 2 min) and the measurement of the insulation resistance is continued. Stored alarm values remain stored. An interruption of the protective earth connections PE1/PE2 causes the same reaction as interrupting the measuring circuit, only the status LED shows flash code 2 in red colour.

Behaviour at parameter failures

With wrong settings on the rotary switches the device goes to failure mode. The indicator relay K2 changes to alarm state and the status LED shows the red flash code 3.

External control input

To terminals X1/X2 an external combined Test-/Reset button can be connected. If the terminals X1/X2 are bridged for approx. > 1.5 s and < 10 s the test mode is started. This has the same function as pressing the internal test button. When bridging X1/X2 for < 1.5 s, a stored alarm will be reset. This has the same function as pressing the internal reset button. If X1/X2 is activated for > 10 s, the measuring function is stopped. The measuring function remains suspended for the duration of the control of X1/X2.

Connection of an external coupling device

An external coupling device RP 5898/240 can be connected to extend the input voltage range of the monitored voltage system on RN 5897/240. The terminals with the same legend of the insulation monitor and the coupling device RL 5898 or RP 5898 (VSG1, VSG2, L(+), L(-)) are connected together. The network to be monitored is connected to terminals L1(+) und L2(-) on the coupling device. Using the rotary switch "Rel./VSG" the connection of the coupling device has to be selected and activated. The broken wire detection is active on the terminals L1(+)/L2(-) on the coupling device. A broken wire between coupling device and insulation monitor cannot be detected immediately but the measured values on interruption of 1 or 2 wires between coupling device and insulation monitor are much lower as the real values, which will cause an early response of the device.

Programming/setting of parameters/set-up of the insulation monitor

All settings are made via 3 rotational switches on the front of the device. To avoid unauthorised manipulation of the settings, the unit has a sealable transparent cover on the front.

The response value for Alarm is adjusted by the first rotary switch "R_A". The second rotary switch "Rel./VSG" is used to alter the relay function as well as for activation/deactivation of the VSG. If set to "n.c." the output is de-energized on trip, If set to "n.o." the output is energized on trip. The VSG is activated in the "on" position and deactivated accordingly in the "off" position. In addition this rotary switch has 2 sections. If the setting is in the section, the broken wire detection in the measuring circuit is activated, if the setting is on the second section, the broken wire detection in the measuring circuit is de-activated.

The third rotational switch selects "UN" selects the voltage system connection and manual or auto reset it has also 2 sections. In section one the unit is on auto reset, in section 2 it is on manual reset. Changes of the setting the unit accepts immediately without restart.

If the second or third rotary switch is in an undefined position, the unit changes to "parameter failure" (see description under "behaviour at parameter failures").

Function Diagram

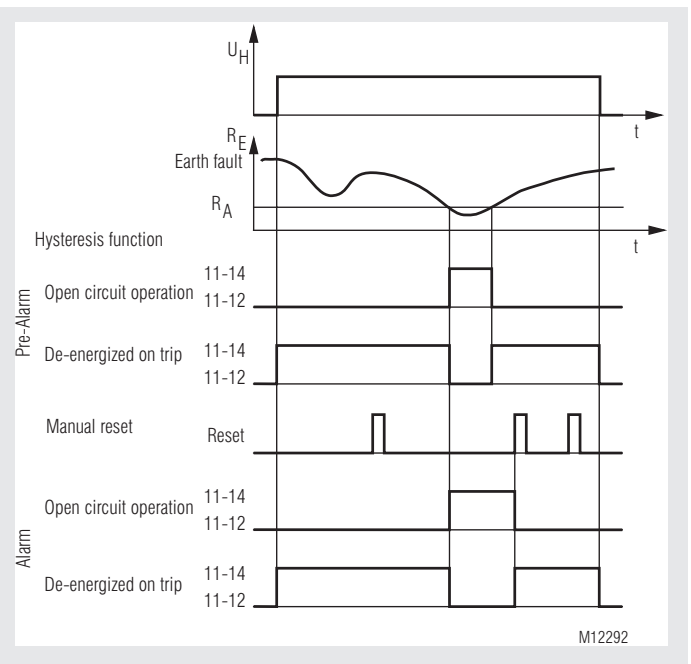

Semiconductor Output (PWM output)

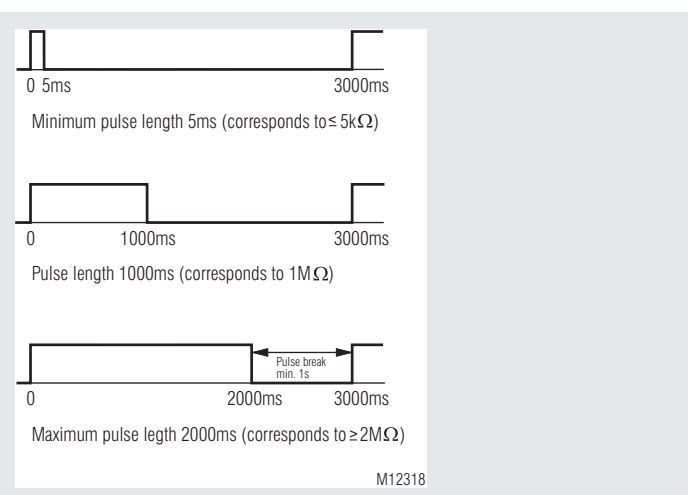

- Broken wire detection: If the PWM-signal is continuously high, a broken wire is detected.
- Short circuit detection: If the PWM-signal is continuously low, the semiconductor may have a short circuit.

Flashing Codes Status LED

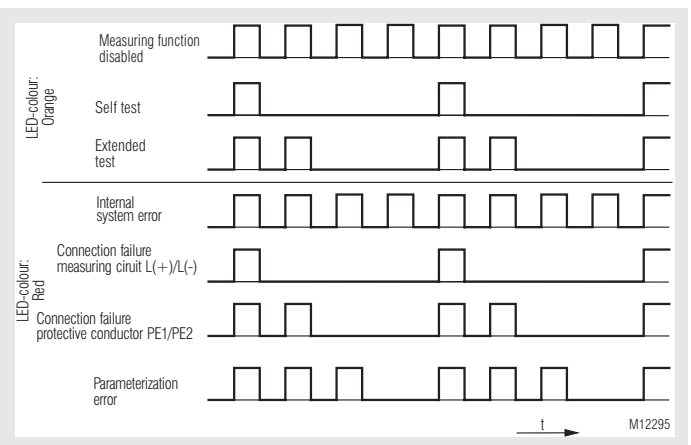

Indicators

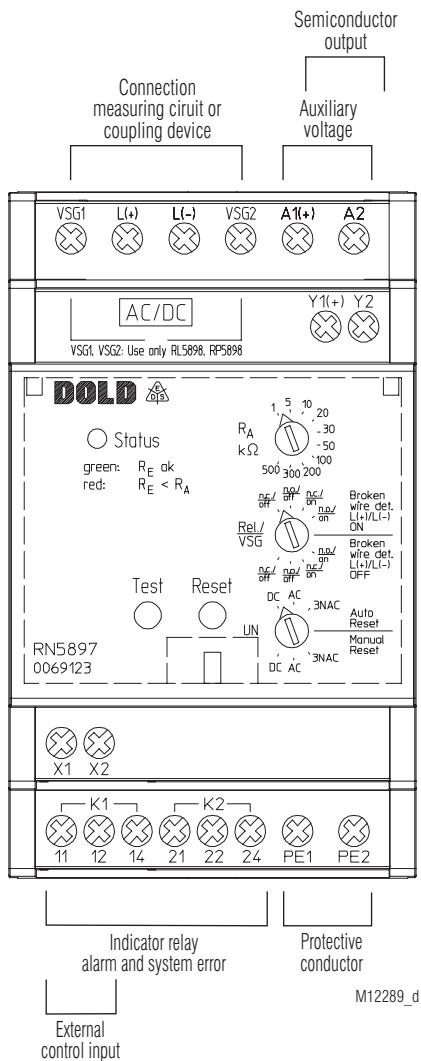

Indicators

The operational status of the device is indicated on a 3-colour LED:

- Off:** No auxiliary voltage connected
- Green:** Normal operation (Insulation resistance in healthy state)
- Red:** Alarm (measured value below alarm response value)
- Orange flashing:** Test mode / Measurement stopped procedure (see flashing code diagramm)
- Red flashing:** Failure code (see flashing code diagramm)

Flash code orange Status-LED	Description
1	Selftest (Measuring circuit, measuring voltage, internal tests)
2	Advanced Test (Additional control of indicator relays)
Continuously flashing	Measuring function stopped

Error Indication

Flash code red Status-LED	Failure cause	Failure recovery
1	Broken wire detection on L(+)/L(-).	Check measuring circuit L(+) and L(-).
2	Broken wire detection on PE1/PE2.	Check protective earth connections PE1 and PE2.
3	Parameter failure	Check position of the rotary switches and avoid undefined setting positions.
Continuously flashing	Internal failure detected in test mode	Press test button again or restart the unit by interrupting the auxiliary supply temporarily. If the fault remains permanent, send device back to manufacturer for examination.
Continuously flashing	Faulty calibration values detected in device memory.	Send device back to manufacturer for recalibration and examination.

Notes



Risk of electrocution! Danger to life or risk of serious injuries.

- Disconnect the system and device from the power supply and ensure they remain disconnected during electrical installation.
- Determine voltage free status by using appropriate instruments
- The terminals of the control input X1-X2 have no galvanic separation to the measuring circuit L(+) and L(-) and are electrically connected together, therefore they have to be controlled by volt free contacts or bridge. These contacts ore bridges must provide a sufficient separation depending on the mains voltage on L(+) - L(-).
- Please do not connect external voltage to terminals X1/X2. The control must only be made by bridging X1 and X2.
- The coupling unit RL 5898 or RP 5898 must only be used in conjunction with the RP5897/240 on a voltage system and not just by itself.

Attention!

- Before checking insulation and voltage, disconnect the monitoring device RN 5897/240 from the power source!
- In one voltage system only one insulation monitor can be used. This has to be observed when interconnecting two separate systems.
- Device terminals PE1 and PE2 must always be connected via separate lines to different terminal points of the protective-conductor system.
- The device must not be operated without PE1/PE2 connection!
- To ensure correct measurement of the insulation resistance, there must be a low-impedance connection ($\leq 10 \text{ k}\Omega$) or a low-impedance internal mains resistance across the source or across the load between the measuring circuit connections L(+) and L(-) (or L1(+) and L2(-) when using the ballast unit).



Attention!

- The main measuring circuit can be connected with its terminals L(+) and L(-) both to the DC and also AC side of a mixed network; it is done most practically where the primary incoming power supply takes place e.g. with battery networks with connected inverters on the DC side, with Generators/Transformers with connected Rectifiers or inverters on the AC-side. To monitor a 3NAC system the device can be connected single pole, (L(+) and L(-) are bridged, to the neutral of the 3p4w system. The 3 phases have a low- Ω ic (approx. 3–5 Ω) connection via the transformer windings so also insulation failures of the not directly connected phases are detected. Via the rotary switch "UN" the correct type of network needs to be selected (see „Connection Examples“).
- If a monitored AC system includes galvanically connected DC circuits (e.g. via a rectifier), an insulation failure on the DC side can only be detected correctly, when a current of min 10 mA can flow via the semiconductor connections.
- If a monitored DC system includes galvanically connected AC circuits (e.g. via an inverter), an insulation failure on the AC side can only be detected correctly, when a current of min 10 mA can flow via the semiconductor connections.
- If the insulation monitor RN 5897/240 is used in an application according to EN 61851-23 annex CC, the insulation resistance value has to be read and evaluated by the supervising PLC, in order to generate a warning according EN 61851-23 annex CC, when the resistance drops below 500 Ohms/V.

Technical Data

Meas. circuit L1(+)/L2(-) to PE1/PE2 (without coupling device)

Nominal voltage U_N:	AC / DC 0 ... 230 V
Max. voltage range U_N:	AC 0 ... 250 V DC 0 ... 300 V
Frequency range:	DC or 40 ... 1000 Hz
Max. line capacitance:	5 μ F
Internal resistance (AC / DC):	> 90 k Ω
Measuring voltage:	Approx. \pm 90 V
Max. measured current ($R_E = 0$):	< 1.10 mA
Response inaccuracy:	\pm 15 % \pm 1.5 k Ω IEC 61557-8
Response value hysteresis:	Approx. + 25 %; min. + 1 k Ω

On delay

at $C_E = 1 \mu$ F,	response value \leq 100 k Ω ,
R_E of ∞ to 0.5 * response value:	\leq 1 s
At $C_E = 1 \mu$ F,	response value > 100 k Ω ,
R_E of ∞ to 0.5 * response value:	< 2 s

Measuring time

at $C_E = 1 \dots 5 \mu$ F:	< 5 s
Min. operate time:	> 0.2 s

Response values

Alarm („RA“)

k Ω :	1	5	10	20	30	50	100	200	300	500
--------------	---	---	----	----	----	----	-----	-----	-----	-----

Each adjustable via rotational switches

Response value broken

wire detection L1(+)/L2(-): > Approx. 90 k Ω

Response value broken

wire detection PE1/PE2: > Approx. 0.5 k Ω

Meas. circuit L1(+)/L2(-) to PE1/PE2 (with coupling device RL / RP 5898)

	RL 5898	RP 5898
Nominal voltage U_N:	AC 0 ... 400 V DC 0 ... 500 V	AC 0 ... 690 V DC 0 ... 1000 V
Max. max. voltage range U_N:	AC 0 ... 440 V DC 0 ... 550 V	AC 0 ... 760 V DC 0 ... 1100 V

Frequency range:	DC or 40 ... 1000 Hz
Max. line capacitance:	5 μ F
Internal resistance (AC / DC):	> 240 k Ω
Measuring voltage:	Approx. \pm 90 V
Max. measured current ($R_E = 0$):	< 0.40 mA
Response inaccuracy:	\pm 15 % \pm 1.5 k Ω IEC 61557-8
Response value hysteresis:	Approx. + 25 %; min. + 1 k Ω

On delay

at $C_E = 1 \mu$ F,	response value \leq 100 k Ω ,
R_E of ∞ to 0.5 * response value:	\leq 1 s
At $C_E = 1 \mu$ F,	response value > 100 k Ω ,
R_E of ∞ to 0.5 * response value:	< 2 s

Measuring time

at $C_E = 1 \dots 5 \mu$ F	< 5 s
Min. operate time:	> 0.2 s

Response values

Alarm („RA“)

k Ω :	1	5	10	20	30	50	100	200	300	500
--------------	---	---	----	----	----	----	-----	-----	-----	-----

Each adjustable via rotational switches

Response value broken

wire detection L1(+)/L2(-): > Approx. 500 k Ω

Response value broken

wire detection PE1/PE2: > Approx. 0.5 k Ω

Max. wire length

between insulation monitor and coupling device: < 0.5 m

Technical Data

Auxiliary voltage input A1(+)/A2

Nom. Voltage	Voltage range	Frequency range
AC/DC 24 ... 60 V	AC 19 ... 68 V	45 ... 400 Hz; DC 48 % W*)
	DC 16 ... 96 V	W*) \leq 5 %
AC/DC 85 ... 230 V	AC 68 ... 276 V	45 ... 400 Hz; DC 48 % W*)
	DC 67 ... 300 V	W*) \leq 5 %
DC 12 ... 24 V	DC 9.6 ... 30 V	W*) \leq 5 %

*) W = Permitted residual ripple of auxiliary supply

Nominal consumption:

DC 12 V, 24 V, 48 V:	Max. 3 W
AC 230 V:	Max. 3.5 VA

Control input X1/X2 for external combined Test-/Reset-Taste

Current flow:	Approx. 3 mA
No-load operation voltage	
X1 to X2:	Approx. 12 V
Permissible wire length:	< 50 m
Activat. time t for test signal:	1.5 s < t < 10 s
Activat. time t for reset signal:	t < 1.5 s
Activation time t for stop of the measuring function:	t > 10 s

Semiconductor output Y1(+)/Y2 with PWM-signal to indicate the actual insulation resistance

Voltage:	Max. 30 V
Current:	Max. 50 mA
Type of circuit:	Open Collector (external supply voltage required)

PWM-signal

period duration:	3000 ms
Frequency:	0.33 Hz
Tolerance period duration:	2 %
Measuring range R_E:	1 ... 2000 k Ω
Resolution:	5 ms (equal to 5 kOhms)

Outputs

Indicator contact:	2 x 1 changeover contact for Alarm (K1) and Pre-Alarm (K2) energized or de-energized on trip (programmable)
Thermal current I_{th}:	Max. 4 A (see also Temperature range Operation)

Switching capacity

to AC 15:		
NO contact:	5 A / AC 230 V	IEC/EN 60947-5-1
NC contact:	2 A / AC 230 V	IEC/EN 60947-5-1
To DC 13:	2 A / DC 24 V	IEC/EN 60947-5-1

Electrical life

at 5 A, AC 230 V: 1 x 10⁵ switching cycles

Short circuit strength

max. fuse rating:	4 A gG / gL	IEC/EN 60947-5-1
Mechanical life:	50 x 10 ⁶ switching cycles	

Technical Data

General Data

Operating mode:	Continuous operation
Temperature range	
Operation:	
Auxiliary voltage	
DC 12 ... 24 V:	
AC/DC 24 ... 60 V:	- 40 ... + 70 °C
Auxiliary voltage	
AC/DC 85 ... 230 V:	- 40 ... + 60 °C - 40 ... + 70 °C (device mounted with min. 1 cm distance to adjacent devices or device with max. 2 x 0.5 A contact current)
Storage:	- 40 ... + 70 °C
Altitude:	≤ 2000 m IEC 60664-1
Clearance and creepage distances	
Rated insulation voltage:	300 V
Overvoltage category:	III
Rated impuls voltage / pollution degree:	IEC 60664-1
Measuring circuit L(+)/L(-) to auxiliary voltage A1(+)/A2 and indicator relay contacts K1, K2 and semiconductor output Y1(+)/Y2: 4 kV / 2	
Auxiliary voltage A1(+)/A2 to indicator relay contacts K1, K2 and semiconductor output Y1(+)/Y2: 4 kV / 2	
Indicator relay contact K1 to indicator relay contact K2: 4 kV / 2	
Semiconductor output Y1(+)/Y2 to indicator relay contacts K1, K2: 4 kV / 2	
Insulation test voltage	
Routine test:	AC 2.5 kV; 1 s
EMC	
Electrostatic discharge (ESD):	8 kV (air) IEC/EN 61326-2-4 IEC/EN 61000-4-2
HF irradiation:	
80 MHz ... 1 GHz:	20 V / m IEC/EN 61000-4-3
1 GHz ... 2.7 GHz:	10 V / m IEC/EN 61000-4-3
Fast transients:	2 kV IEC/EN 61000-4-4
Surge voltage between wires for power supply:	1 kV IEC/EN 61000-4-5
Between wire and ground:	2 kV IEC/EN 61000-4-5
HF-wire guided:	20 V IEC/EN 61000-4-6
Interference suppression:	Limit value classe B EN 55011
Degree of protection	
Housing:	IP 30 (not sealed) IEC/EN 60529 IP 40 (sealed with seal wire 50/30) IEC/EN 60529 The unit must be disconnected from the power supply before the seal is applied
Terminals:	IP 20 IEC/EN 60529
Housing:	Thermoplastic with V0 behaviour according to UL subject 94
Vibration resistance:	Amplitude 0.35 mm, Frequency 10 ... 55 Hz, IEC/EN 60068-2-6 frequency 2 ... 13.2 Hz, 13.2 ... 100 Hz, acceleration ± 0.7 gn IEC/EN 60068-2-6 10 gn / 11 ms, 3 pulses IEC/EN 60068-2-27 40 / 070 / 04 IEC/EN 60068-1 EN 50005
Shock resistance:	
Climate resistance:	
Terminal designation:	
Wire connection	DIN 46228-1/-2/-3/-4
Cross section:	0.5 ... 4 mm ² (AWG 20 - 10) solid or 0.5 ... 4 mm ² (AWG 20 - 10) stranded wire without ferrules 0.5 ... 2.5 mm ² (AWG 20 - 10) stranded wire with ferrules
Stripping length:	6.5 mm
Wire fixing:	Cross-head screw / M3 box terminals
Fixing torque:	0.5 Nm
Mounting:	DIN rail IEC/EN 60715
Weight:	Approx. 205 g

Dimensions

Width x height x depth: 52.2 x 90 x 71 mm

Classification to DIN EN 50155

Vibration and shock resistance:	Category 1, Class B	IEC/EN 61373
Service temperature classes:	OT1, OT2 compliant	
Protective coating of the PCB:	No	

UL-Data

Meas. circuit L1(+)/L2(-) to PE1/PE2 (with coupling device RL / RP 5898)

	RL 5898	RP 5898
Max. voltage range U_n:	AC 0 ... 400 V DC 0 ... 500 V	AC 0 ... 600 V DC 0 ... 600 V
Output voltage at L(+)/L(-), VSG1/VSG2:	Max. AC / DC 230 V	
Temperature range		
Operation:	- 30 ... + 60 °C	
Switching capacity:	Pilot duty C300, R300 5A 250Vac 2A 30Vdc	
Wire connection:	60 °C / 75 °C copper conductors only Torque 0.5 Nm	
Test specification:	ANSI/UL 60947-1, 5 th Edition ANSI/UL 60947-5-1, 3 rd Edition CAN/CSA-C22.2 No. 60947-1-13, 2 nd Edition CAN/CSA-C22.2 No. 60947-5-1-14, 1 st Edition	



Technical data that is not stated in the UL-Data, can be found in the technical data section.

CCC-Data

Switching capacity	
to AC 15	
NO contact:	3 A / AC 230 V
NC contact:	1 A / AC 230 V



Technical data that is not stated in the CCC-Data, can be found in the technical data section.

Standard Types

- RN 5897.12/240/61 DC 12 ... 24 V
 Article number: 0069124
 • Auxiliary voltage: DC 12 ... 24 V
- RN 5897.12/240/61 AC/DC 24 ... 60 V
 Article number: 0069123
 • Auxiliary voltage: AC/DC 24 ... 60 V
- RN 5897.12/240/61 AC/DC 85 ... 230 V
 Article number: 0069125
 • Auxiliary voltage: AC/DC 85 ... 230 V
- Outputs: 1 changeover contact for device fault
1 changeover contact for alarm
 - Setting range alarm: 1 k Ω ... 500 k Ω
 - With connection facility of a coupling device RL 5898 or RP 5898
 - Max. line capacitance: 5 μ F
 - Energized or de-energized on trip
 - Selection of type of network
 - Width: 52.5 mm

Ordering Example for variants

RN 5897 .12 /240 /61 AC/DC 24 ... 60 V 1 k Ω - 100 k Ω 20 k Ω - 500 M Ω

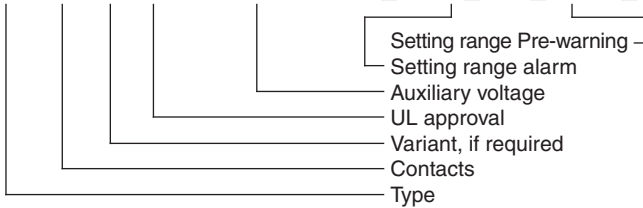

Accessories

- RP 5898/61
 Article number: 0066944
- Coupling device for RN 5897.12/240
 - Extension of nominal voltage range U_N to DC 1000 V, AC 690 V
 - Weight: Approx. 110 g
 - Dimensions
 - Width x height x depth: 70 x 90 x 71 mm

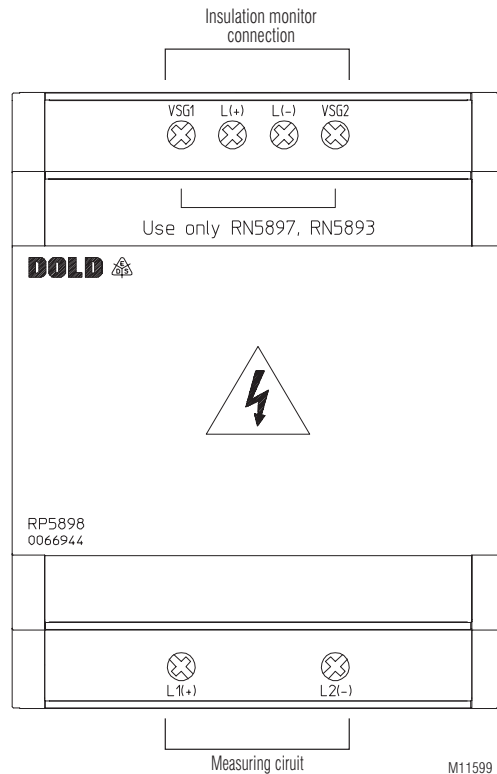

Accessories

- RL 5898/61
 Article number: 0068315
- Coupling device for RN 5897.12/240
 - Extension of nominal voltage range U_N to DC 500 V, AC 400 V
 - Weight: Approx. 60 g
 - Dimensions
 - Width x height x depth: 35 x 90 x 71 mm

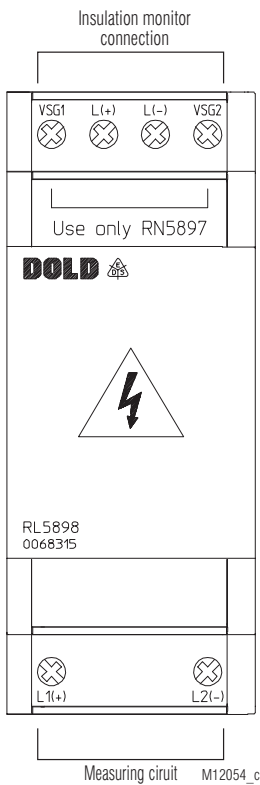

Flush mounting kit

Order reference: KU 4087-150/0056598

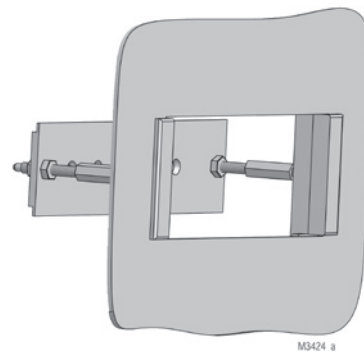

- For universal use with:
- R-series devices of 17.5 to 105 mm width
 - Easy mounting

Connection Examples

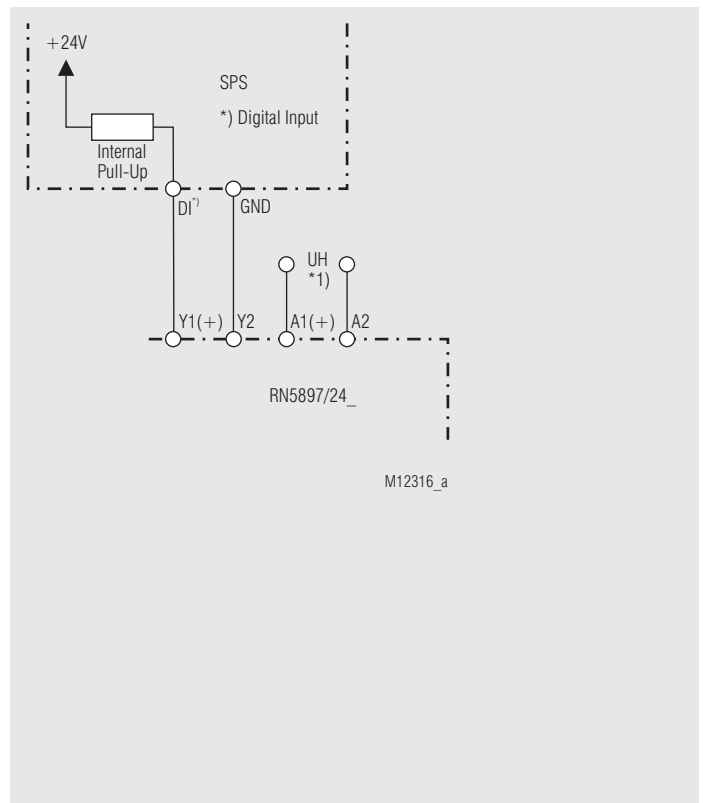
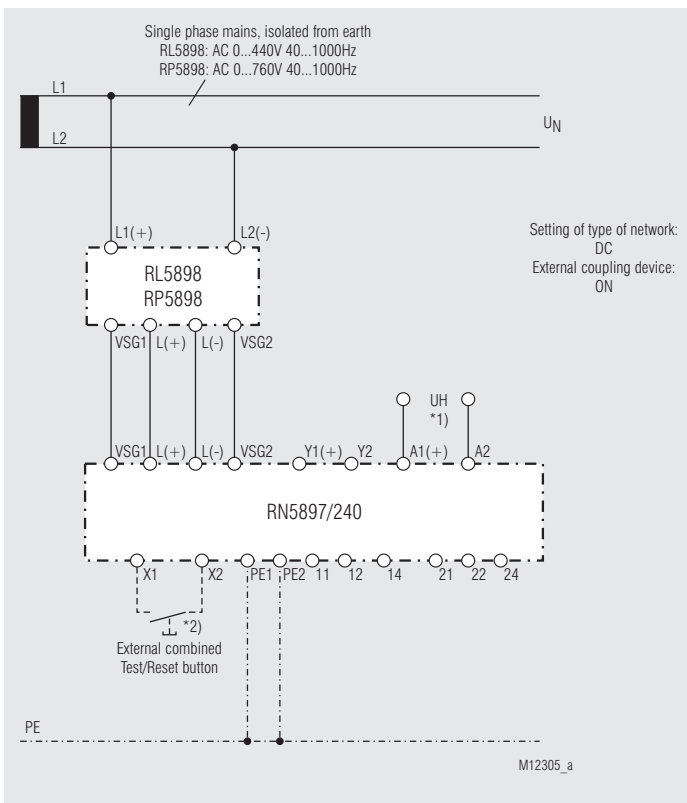
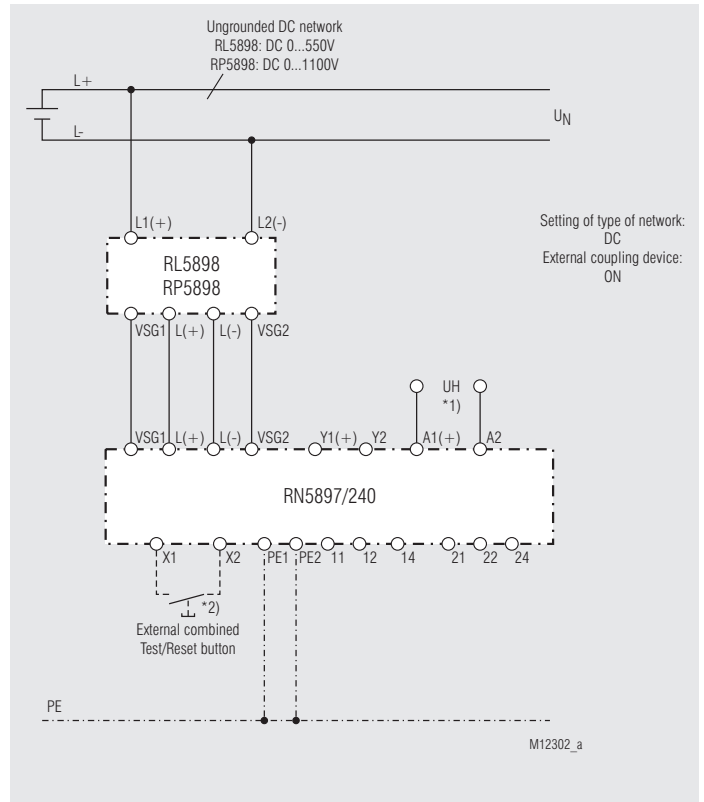
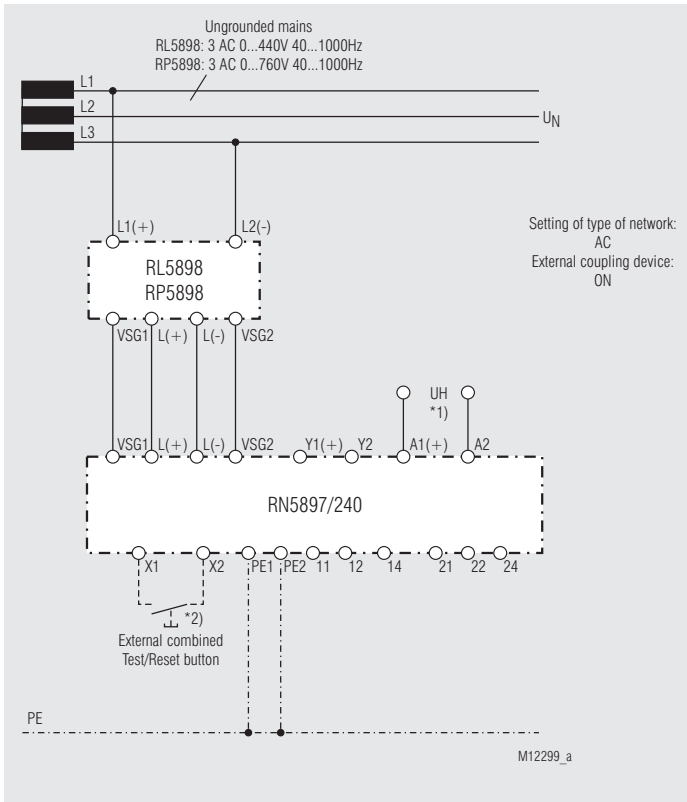

*1) Auxiliary voltage U_H (A1(+)/A2) can also be sourced from the monitored voltage system. The voltage range of the auxiliary supply has to be taken into account.

*2) Control input X1/X2 for external combined Test-/Reset-button with Stop of the measuring function:

- Control 1.5 s < t < 10 s: Test function
- Control < 1.5 s: Reset function
- Control > 10 s: Stop of measuring function

Connection Examples

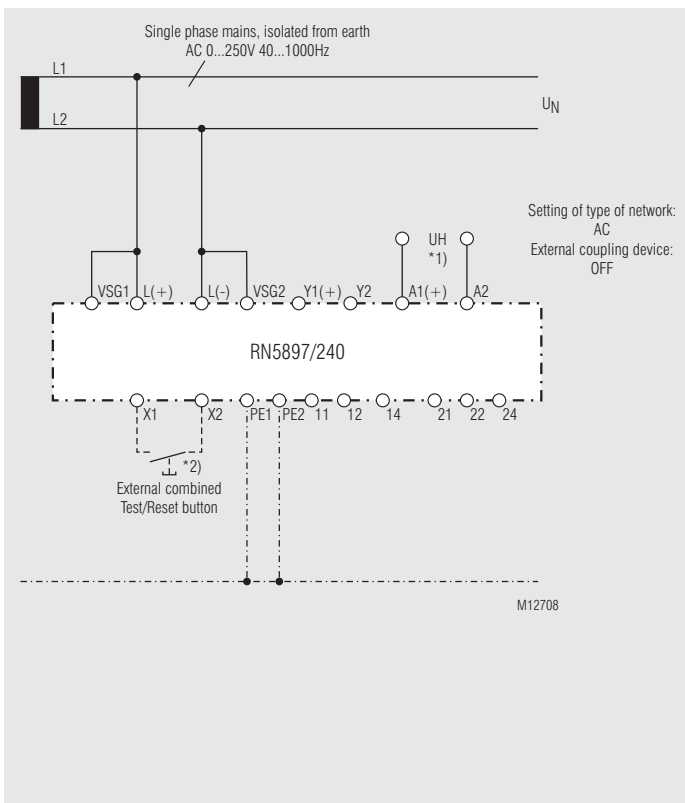
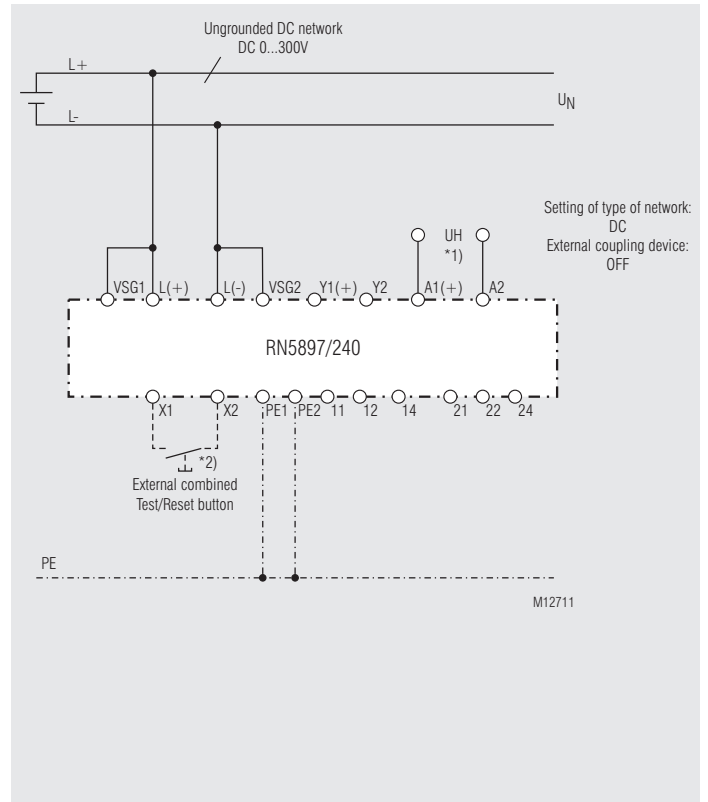
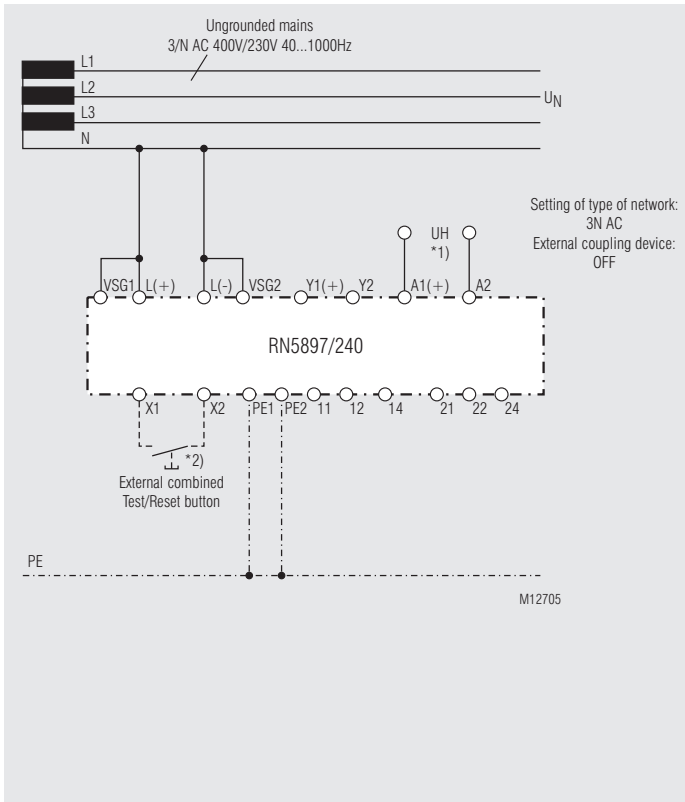

*1) Auxiliary voltage U_H (A1(+)/A2)) can also be sourced from the monitored voltage system.
The voltage range of the auxiliary supply has to be taken into account.

*2) Control input X1/X2 for external combined Test-/Reset-button with Stop of the measuring function:

- Control 1.5 s < t < 10 s: Test function
- Control < 1.5 s: Reset function
- Control > 10 s: Stop of measuring function

