

Datasheet

020STAMLORW

Knob selector switch, illuminated, red, 3-position, Cam O, metal



Features

| | |
|-----------------------|--|
| Range | Illuminated knob selector switches Ø 22 - metal bezel |
| components | 3-position |
| Code | 020STAMLORW |
| Description | Knob selector switch, illuminated, red, 3-position, Cam O, metal |
| Colour | Rosso |
| Weight - gr | 38.0 |
| Customs Tariff | 85365080 |
| GTIN | 8052878024864 |

Datasheet

| | |
|---|---|
| Approvals | CE |
| Compliance with standards | IEC-EN60947-1, IEC-EN60947-5-1, UL508, CSA C22-2 |
| Compliance with standards | UNI CEI EN 45545-2 |
| Operating temperatures | -25° ÷ +65°C |
| Environmental operating values | +25°C-97%RH / +45°C-93%RH (IEC-EN60068-2-30) |
| Protection degree | IP65 (IEC-EN60529) |
| Protection against impact | IK03 (IEC-EN62262) |
| Mechanical durability | 1.000.000 Operations |
| Shock resistance | 30g duration=18ms (EN-IEC 60068-2-27) |
| Shock resistance | 50g duration=11ms (EN-IEC 60068-2-27) |
| Vibration resistance | 5g f= 2...500Hz (EN-IEC 60068-2-6) |
| Contact blocks configuration | Max no. 2 blocks (1+1) |
| Knob or lever material | PC Polycarbonate |
| External bezel material | Chromed zinc alloy |
| Locking ring material | Zamak zinc alloy |
| Fixing diameter | 22.5mm - Thickness 1÷6mm |
| Tightening torque | 2 ÷ 3Nm (17.7 ÷ 26.6 Lb-in) |
| Illuminated selector switch (all versions) | It is mandatory to use LED bulbs type 010BA9SLxxx |
| Protection against electric shock | Class II (IEC-EN61140) |
| Warranty period | 18 months |

Technical drawings

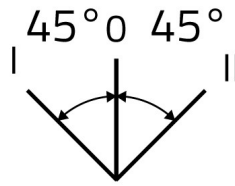
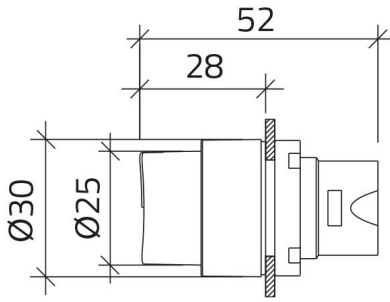

CAM O

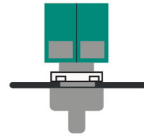
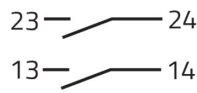
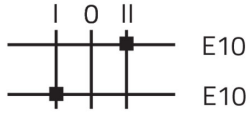
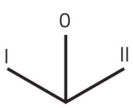

020E10
020E10
020G

CAM O

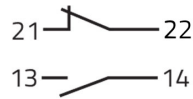
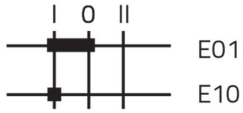
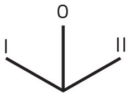

020E01
020E10
020G

