

[Article Page](#)

Product Description

inductive sensor NAMUR

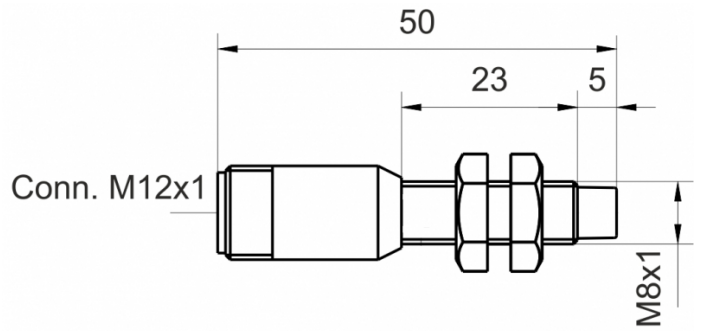

Name
Order number
Matchcode
Switching distance
Mounting

Signal Type
Connection
Connection diagramm

KJ2-M8MN50-NA-V2
08317320265
9932-0265
2 mm

 non shielded
Namur
connector M12

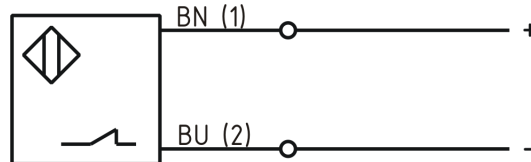

fine-pitch thread M8 x 50

Dimension (in mm)
Technical Specification
Operating voltage
Max. ripple
No load current
Switching frequency
Operating temperature
Temperature drift
Repeat accuracy
Time delay
Short-circuit proof
Overload protection
Reverse voltage protection
Protection category
EMC-level
Housing material
Material active face
Utilisation category
Contact material
Contact surface material
Contact holder
Nominal operating voltage
Termination
Load Current OFF
Load Current ON

6 - 12 VDC
≤ 5 %
≤ 3,5 mA
1000 Hz
-25 ° C to 60 ° C
≤ 10 %
≤ 10 %
100 ms
yes
yes
yes
IP67
DIN EN 60947-5-6:2000-12
Brass, nickel plated
PCB
DC 13
CuSn
NiAu
PA 6
8,2 V DC
Connector M12 4pin
ca. 0,5 mA
ca. 3,5 mA



KJ2-M8MN50-NA-V2

Pulsotronic GmbH & Co. KG Neue Schichtstraße 14b 09366 Niederdorf Deutschland +49 (0)37296 930-200

FIT / MTTF acc. to SIEMENS 29500

18,38 / 6211y

Errors and omissions exceptet