

[Article Page](#)

Product Description

reflex light probe with background suppression

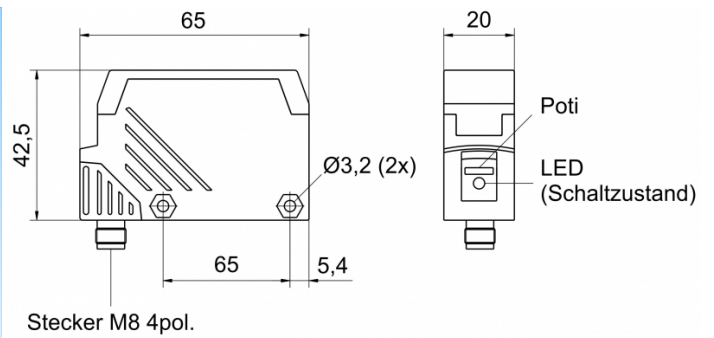
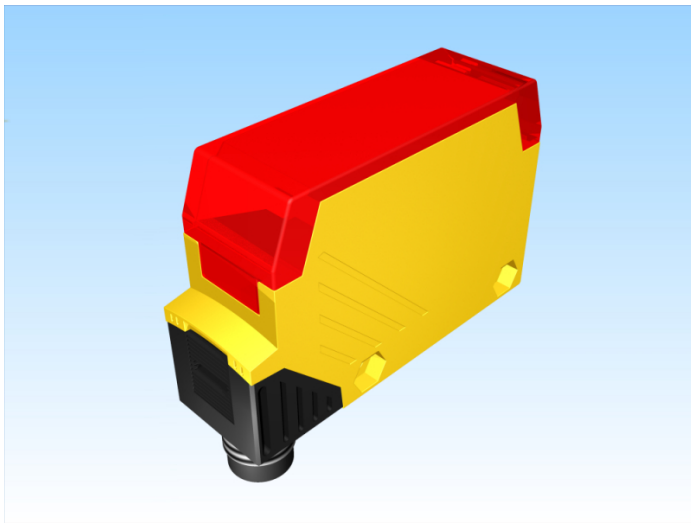

Name
Order number
art_schaltabstand_einstellbar
Switching distance
Switch type

KORH500-Q64KB-DNU-V1-RT
08361215019
yes
from 150 mm to 500 mm



Switchable

Signal Type
Illuminant
Connection
Connection diagramm

NPN
● Red light 650 nm
connector M8

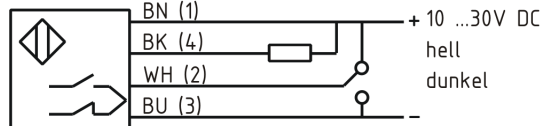

Q 20 x 60 x 43

Dimension (in mm)
Technical Specification
Signal type
Operating voltage
Max. load current
No load current
Switching frequency
Operating temperature
Switching state
Short-circuit proof
Overload protection
Reverse voltage protection
Protection category
EMC-level
Housing material
Termination

Background suppression sensor
10 - 30 V DC
100 mA
< 35 mA
33 Hz
-25 ° C to 55 ° C
LED
yes
yes
yes
IP67
DIN EN 60947-5-2:2008
Plastic
Connector M8 4pol

Errors and omissions exceptet