

[Article Page](#)

Product Description

reflex light probe

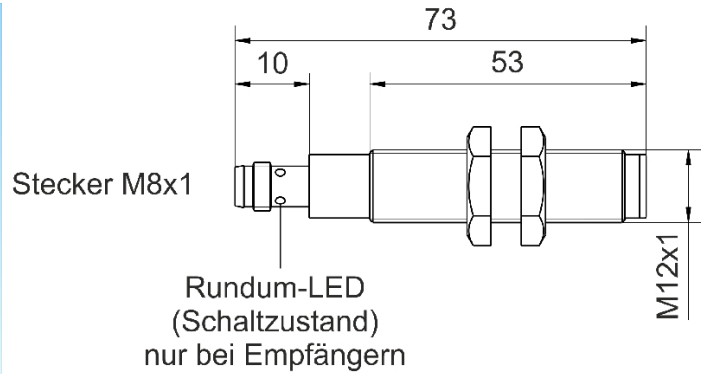

Name
Order number
Switching distance
Switch type

KORT200-M12MB73-DPA-V1-IR
08361245125
from 200 mm to 200 mm

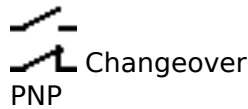

IR Infrared light 880 nm

Signal Type
Illuminant
Connection



Connection diagramm

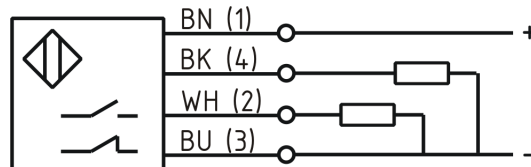

M12 x 73

Dimension (in mm)
Technical Specification
Signal type
Operating voltage
Max. load current
No load current
Switching frequency
Operating temperature
Switching state
Short-circuit proof
Overload protection
Reverse voltage protection
Protection category
EMC-level
Termination

Diffuse mode sensor
10 - 30 V DC
150 mA
< 30 mA
500 Hz
-25 ° C to 70 ° C
LED
yes
yes
yes
IP67
DIN EN 60947-5-2:2008
Connector M8 4pol

Errors and omissions exceptet