

[Article Page](#)

Product Description

inductive sensor DC

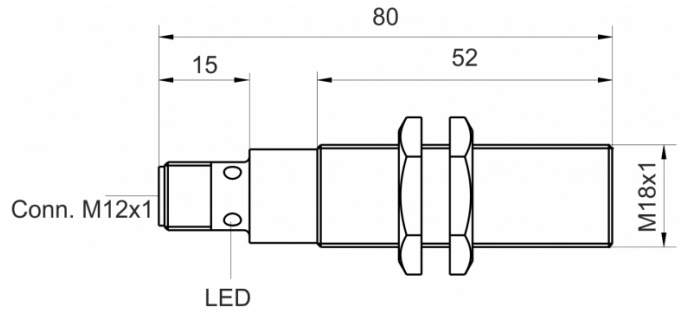
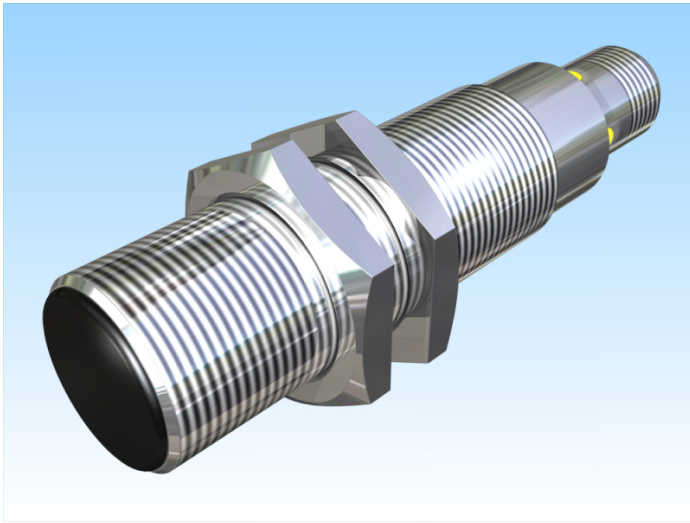

Name
Order number
Switching distance
Mounting

Switch type

Signal Type
Connection
Connection diagramm

SJ12-M18MB76-DNS-V2
08313121832
12 mm

 shielded

 N.O.
DC NPN
connector M12

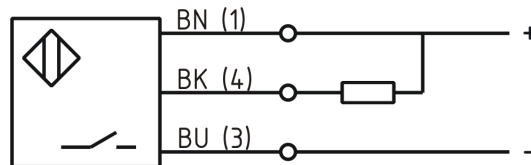

fine-pitch thread M18 x 80

Dimension (in mm)
Technical Specification
Special features
Operating voltage
Max. ripple
Voltage drop
Max. load current
No load current
Leakage current
Switching frequency
Switching hysteresis
Operating temperature
Temperature drift
Repeat accuracy
Switching state
Time delay
Short-circuit proof
Overload protection
Reverse voltage protection
Protection category
EMC-level
Housing material
Material active face

quasi-shielded mounting
10 - 30 VDC
≤ 10 %
2 V
200 mA
≤ 10 mA
≤ 50 μA
500 Hz
≤ 15 %
-25 ° C to 70 ° C
≤ 10 %
≤ 5 %
LED
300 ms
yes
yes
yes
IP67
DIN EN 60947-5-2:2008
Brass, nickel plated
PBT



SJ12-M18MB76-DNS-V2

Pulsotronic GmbH & Co. KG Neue Schichtstraße 14b 09366 Niederdorf Deutschland +49 (0)37296 930-200

Utilisation category	DC 13
Contact material	CuSn
Contact surface material	NiAu
Nominal operating voltage	24 V DC
Termination	Connector M12 4pin

Errors and omissions exceptet