

[Article Page](#)

Product Description

inductive sensor DC

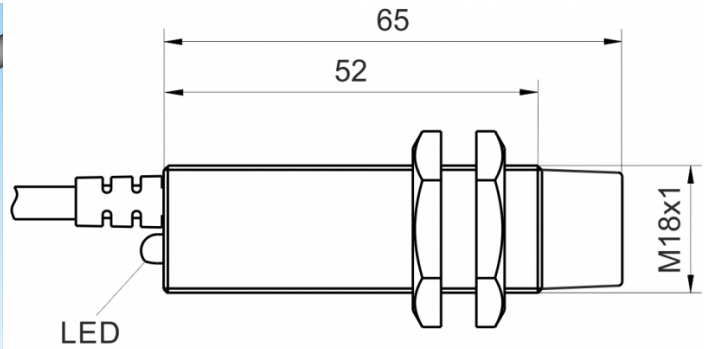

Name  
Order number  
Switching distance  
Mounting

SJ20-M18MN65-DNÖ  
08313182047  
20 mm

non shielded

Switch type

N.C.  
DC NPN

Signal Type  
Connection

Cable

Connection diagramm

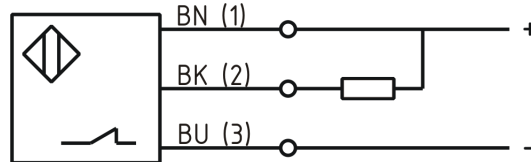

fine-pitch thread M18 x 65

Dimension (in mm)  
Technical Specification  
Operating voltage  
Max. ripple  
Voltage drop  
Max. load current  
No load current  
Leakage current  
Switching frequency  
Switching hysteresis  
Operating temperature  
Temperature drift  
Repeat accuracy  
Switching state  
Time delay  
Short-circuit proof  
Overload protection  
Reverse voltage protection  
Protection category  
EMC-level  
Housing material  
Material active face

10 - 30 VDC  
≤ 10 %  
2 V  
200 mA  
≤ 10 mA  
≤ 50 μA  
300 Hz  
≤ 15 %  
-25 ° C to 70 ° C  
≤ 10 %  
≤ 5 %  
LED  
300 ms  
yes  
yes  
yes  
IP67  
DIN EN 60947-5-2:2008  
Brass, nickel plated  
PBT



## SJ20-M18MN65-DNÖ

Pulsotronic GmbH & Co. KG Neue Schichtstraße 14b 09366 Niederdorf Deutschland +49 (0)37296 930-200

Cable length	2 m
Utilisation category	DC 13
Cable material	PVC LIYY grau (grey)
Nominal operating voltage	24 V DC
Cable cross	3x0.34 mm <sup>2</sup>

**Errors and omissions exceptet**